

CMSH5-100HV
 CMSH5-150HV
 CMSH5-200HV

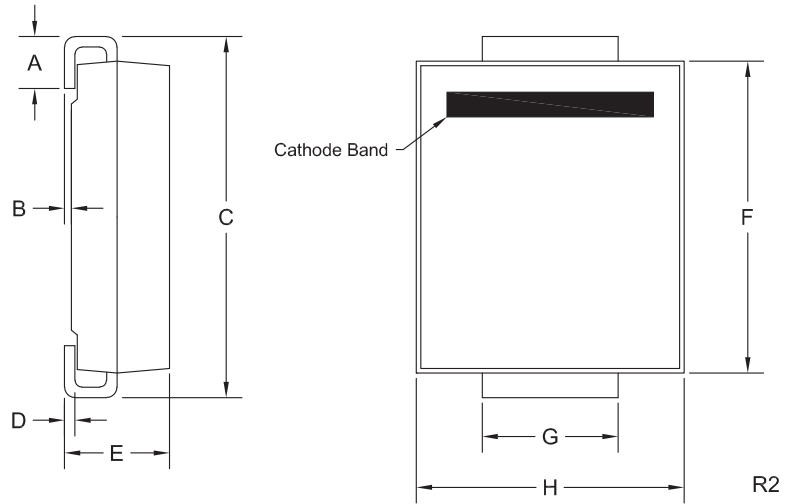

**SURFACE MOUNT SILICON
 SCHOTTKY RECTIFIERS
 5.0 AMP, 100 THRU 200 VOLT**

SMC CASE - MECHANICAL OUTLINE



DEVICE	MARKING CODE
CMSH5-100HV	CS510HV
CMSH5-150HV	CS515HV
CMSH5-200HV	CS520HV

SYMBOL	DIMENSIONS			
	INCHES		MILLIMETERS	
	MIN	MAX	MIN	MAX
A	0.030	0.060	0.76	1.52
B	0.002	0.008	0.05	0.20
C	0.305	0.320	7.75	8.13
D	0.006	0.012	0.15	0.31
E	0.079	0.103	2.00	2.62
F	0.260	0.280	6.60	7.11
G	0.108	0.128	2.75	3.25
H	0.220	0.245	5.59	6.22

SMC (REV: R2)

R4 (22-December 2015)

CMSH5-100HV
 CMSH5-150HV
 CMSH5-200HV



SURFACE MOUNT SILICON
 SCHOTTKY RECTIFIERS
 5.0 AMP, 100 THRU 200 VOLT

TYPICAL ELECTRICAL CHARACTERISTICS

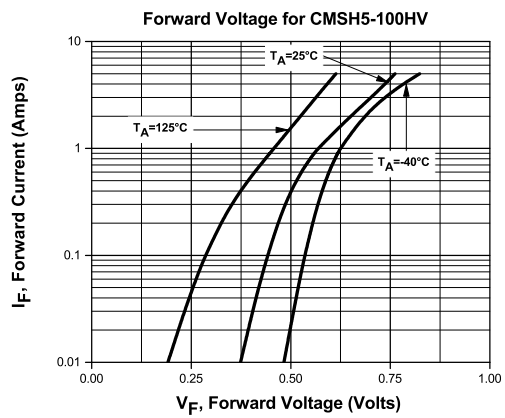
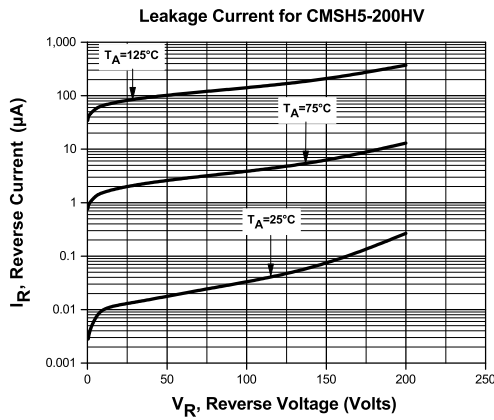
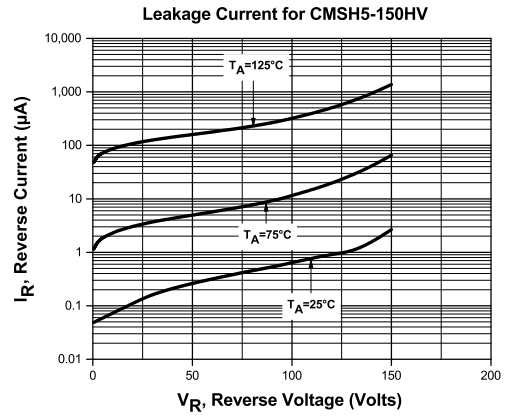
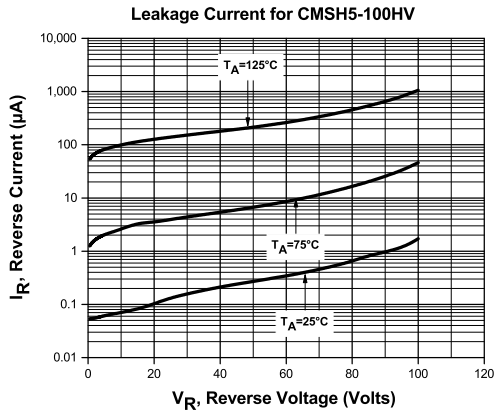

R4 (22-December 2015)

CMSH5-100HV
 CMSH5-150HV
 CMSH5-200HV



SURFACE MOUNT SILICON
 SCHOTTKY RECTIFIERS
 5.0 AMP, 100 THRU 200 VOLT

TYPICAL ELECTRICAL CHARACTERISTICS

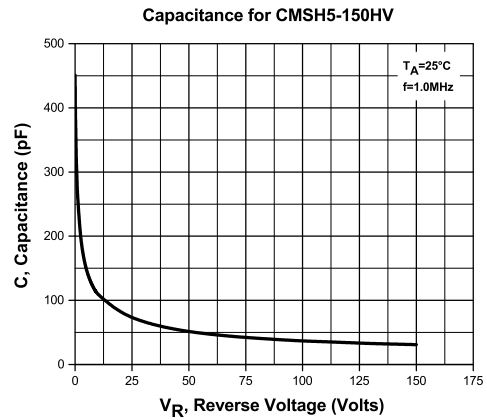
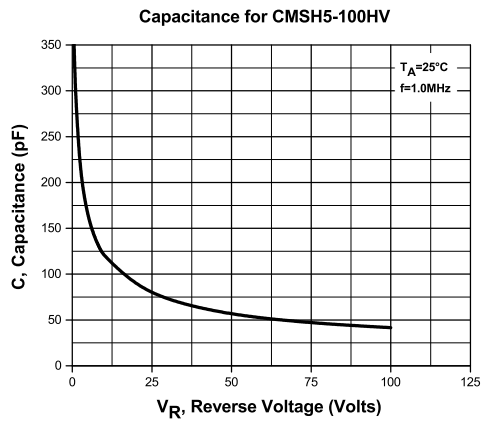
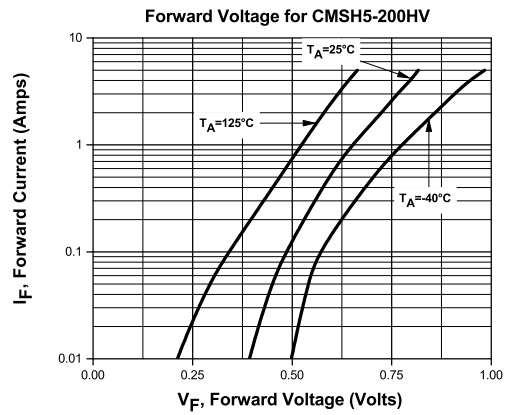
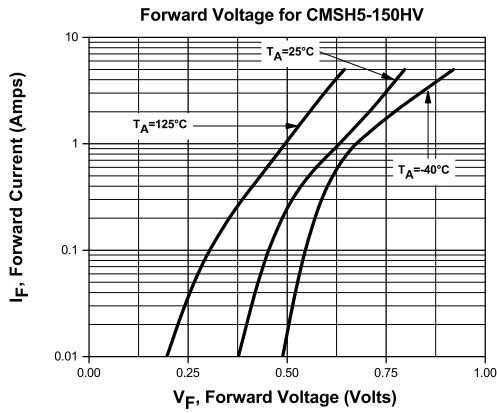

R4 (22-December 2015)

CMSH5-100HV
CMSH5-150HV
CMSH5-200HV

SURFACE MOUNT SILICON
SCHOTTKY RECTIFIERS
5.0 AMP, 100 THRU 200 VOLT



TYPICAL ELECTRICAL CHARACTERISTICS

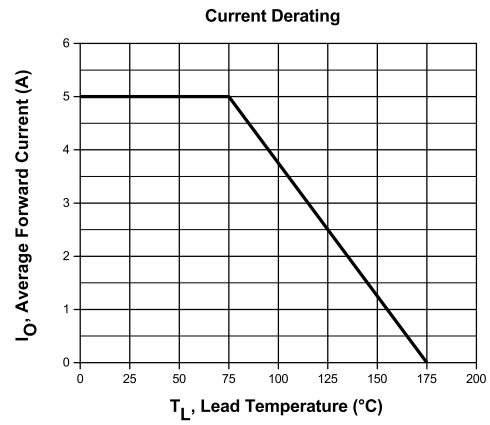
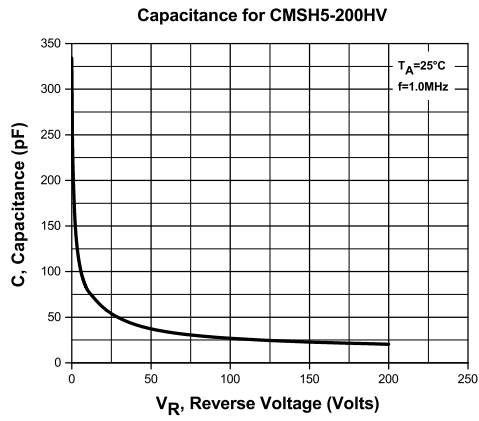

R4 (22-December 2015)

OUTSTANDING SUPPORT AND SUPERIOR SERVICES



PRODUCT SUPPORT

Central's operations team provides the highest level of support to insure product is delivered on-time.

- Supply management (Customer portals)
- Inventory bonding
- Consolidated shipping options
- Custom bar coding for shipments
- Custom product packing

DESIGNER SUPPORT/SERVICES

Central's applications engineering team is ready to discuss your design challenges. Just ask.

- Free quick ship samples (2nd day air)
- Online technical data and parametric search
- SPICE models
- Custom electrical curves
- Environmental regulation compliance
- Customer specific screening
- Up-screening capabilities
- Special wafer diffusions
- PbSn plating options
- Package details
- Application notes
- Application and design sample kits
- Custom product and package development

REQUESTING PRODUCT PLATING

1. If requesting Tin/Lead plated devices, add the suffix " TIN/LEAD" to the part number when ordering (example: 2N2222A TIN/LEAD).
2. If requesting Lead (Pb) Free plated devices, add the suffix " PBFREE" to the part number when ordering (example: 2N2222A PBFREE).

CONTACT US

Corporate Headquarters & Customer Support Team

Central Semiconductor Corp.
145 Adams Avenue
Hauppauge, NY 11788 USA
Main Tel: (631) 435-1110
Main Fax: (631) 435-1824
Support Team Fax: (631) 435-3388
www.centrasemi.com

Worldwide Field Representatives:
www.centrasemi.com/wwreps

Worldwide Distributors:
www.centrasemi.com/wwdistributors

For the latest version of Central Semiconductor's **LIMITATIONS AND DAMAGES DISCLAIMER**, which is part of Central's Standard Terms and Conditions of sale, visit: www.centrasemi.com/terms