

1 Characteristics

Table 1: Absolute maximum ratings ($T_{amb} = 25\text{ }^{\circ}\text{C}$)

Symbol	Parameter		Value	Unit
V_{pp}	Peak pulse voltage ⁽¹⁾	ISO 10605 (C = 330 pF, R = 330 Ω):		
		Contact discharge	30	kV
		Air discharge	30	
		ISO 10605 (C = 150 pF, R = 330 Ω):		
Contact discharge	30			
	Air discharge	30		
P_{pp}	Peak pulse power (8/20 μs)		300	W
I_{pp}	Peak pulse current (8/20 μs)	ESDA5V3LY	25	A
		ESDA6V1LY	18	
		ESDA14V2LY	14	
		ESDA25LY	7	
		ESDA37LY	6.3	
T_j	Operating junction temperature range		-40 to 150	$^{\circ}\text{C}$
T_{stg}	Storage junction temperature range		-65 to 150	$^{\circ}\text{C}$
T_L	Maximum temperature for soldering during 10 s		260	$^{\circ}\text{C}$

Notes:

(1)For a surge greater than the maximum values, the diode will fail in short-circuit.

Figure 2: Electrical characteristics (definitions)

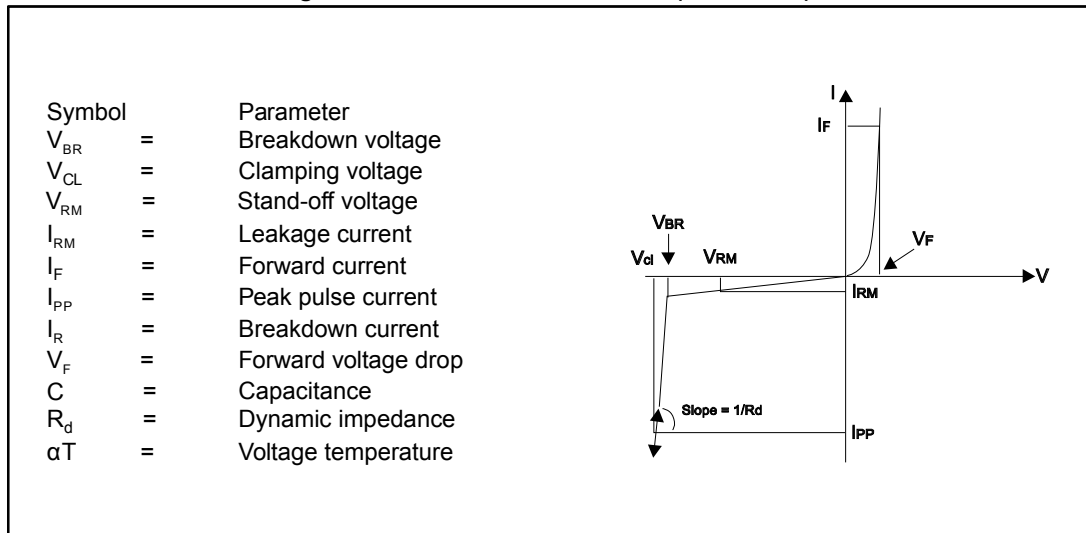

Table 2: Electrical characteristics ($T_{amb} = 25\text{ °C}$)

Order code	V_{BR} at I_R			I_{RM} at V_{RM}		$R_d^{(1)}$	$\alpha T^{(2)}$	C_{line}	V_F at I_F	
	Min.	Max.		Max.		Typ.	Max.	Typ. at 0 V bias	Max.	
	V	V	mA	μA	V	m Ω	$10^{-4}/\text{°C}$	pF	V	mA
ESDA5V3LY	5.3	5.9	1	2	3	280	5	220	1.25	200
ESDA6V1LY	6.1	7.2	1	20	5.25	350	6	140	1.25	200
ESDA14V2LY	14.2	15.8	1	5	12	650	11	90	1.25	200
ESDA25LY	25	30	1	1	24	1000	11	50	1.2	10
ESDA37LY	37	43.3	1	1	36	2400	11	48	0.9	10

Notes:

⁽¹⁾Square pulse $I_{pp} = 15\text{ A}$, $t_p = 2.5\ \mu\text{s}$

⁽²⁾ $\Delta V_{BR} = \alpha T \times (T_{amb} - 25\text{ °C}) \times V_{BR}(25\text{ °C})$

1.1 Characteristics (curves)

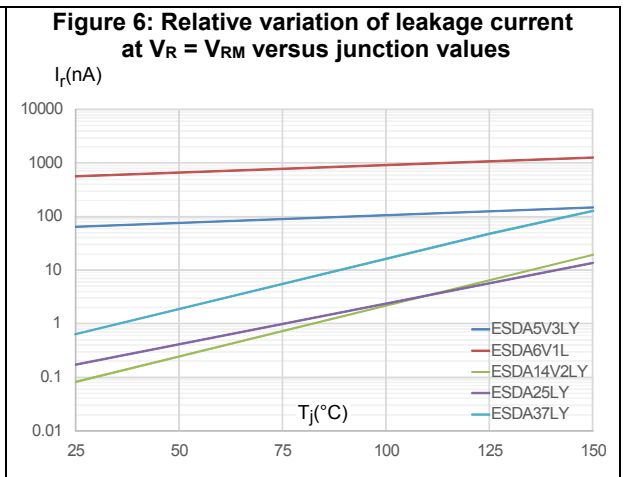
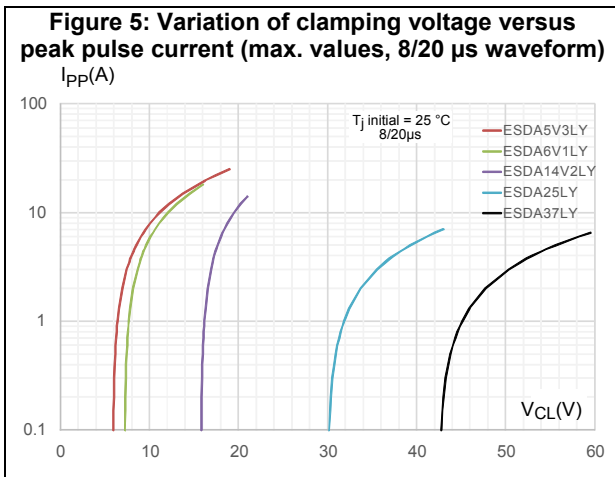
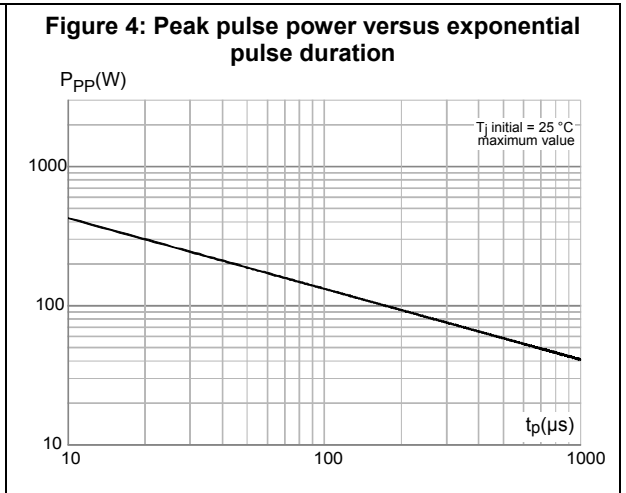
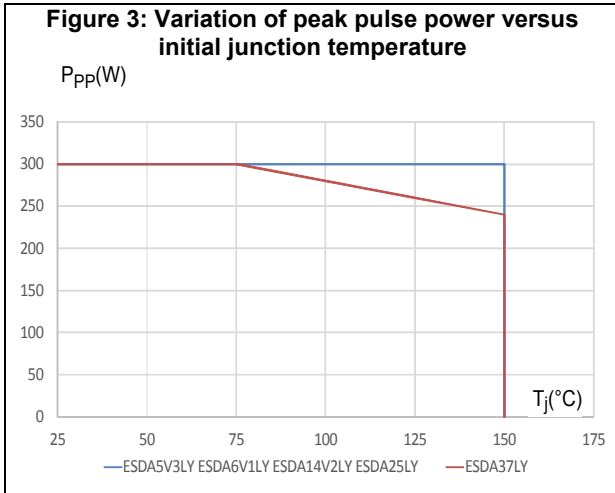

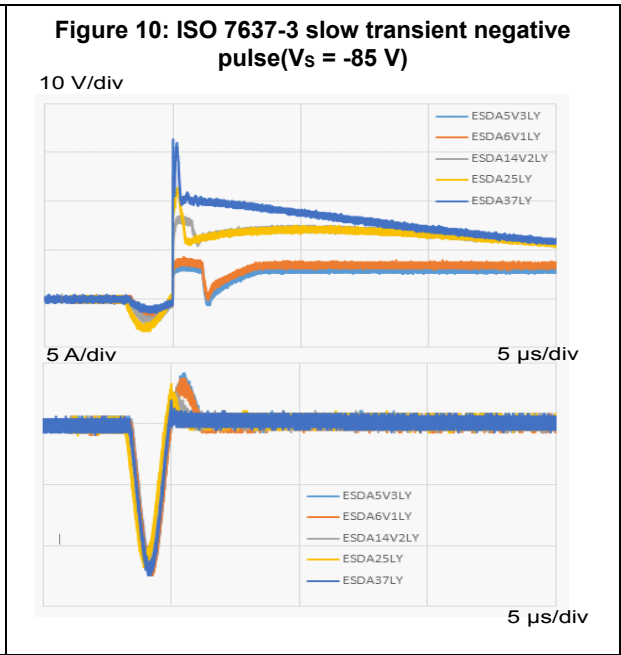
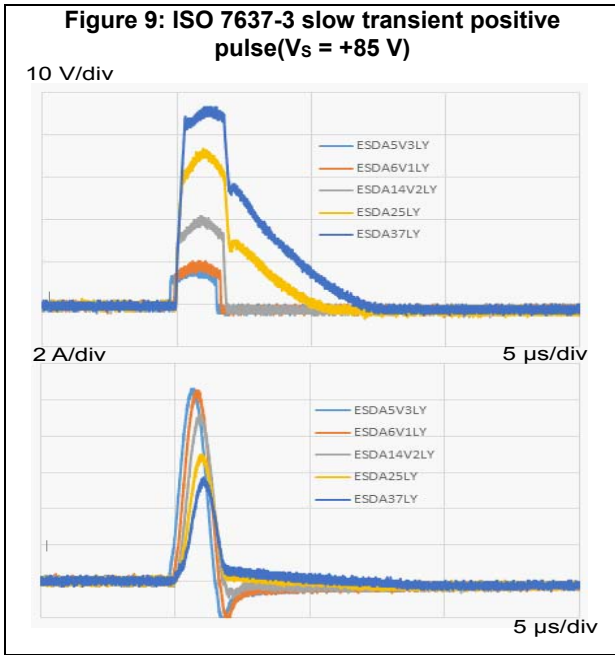
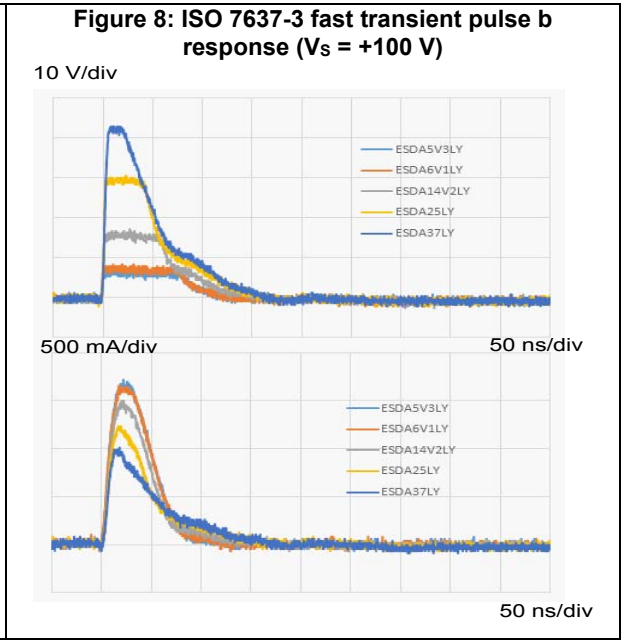
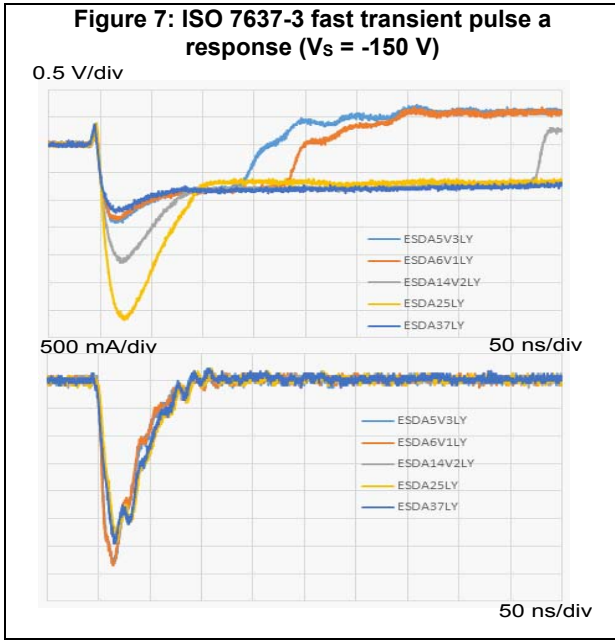

2 Application and design guidelines

Refer to STMicroelectronics application note:

- AN2689: Protection of automotive electronics from electrical hazards, guidelines for design and component selection.

3 Package information

In order to meet environmental requirements, ST offers these devices in different grades of ECOPACK® packages, depending on their level of environmental compliance. ECOPACK® specifications, grade definitions and product status are available at: www.st.com. ECOPACK® is an ST trademark.

- Epoxy meets UL 94,V0
- Lead-free package

3.1 SOT23-3L mechanical data

Figure 11: SOT23-3L package outline

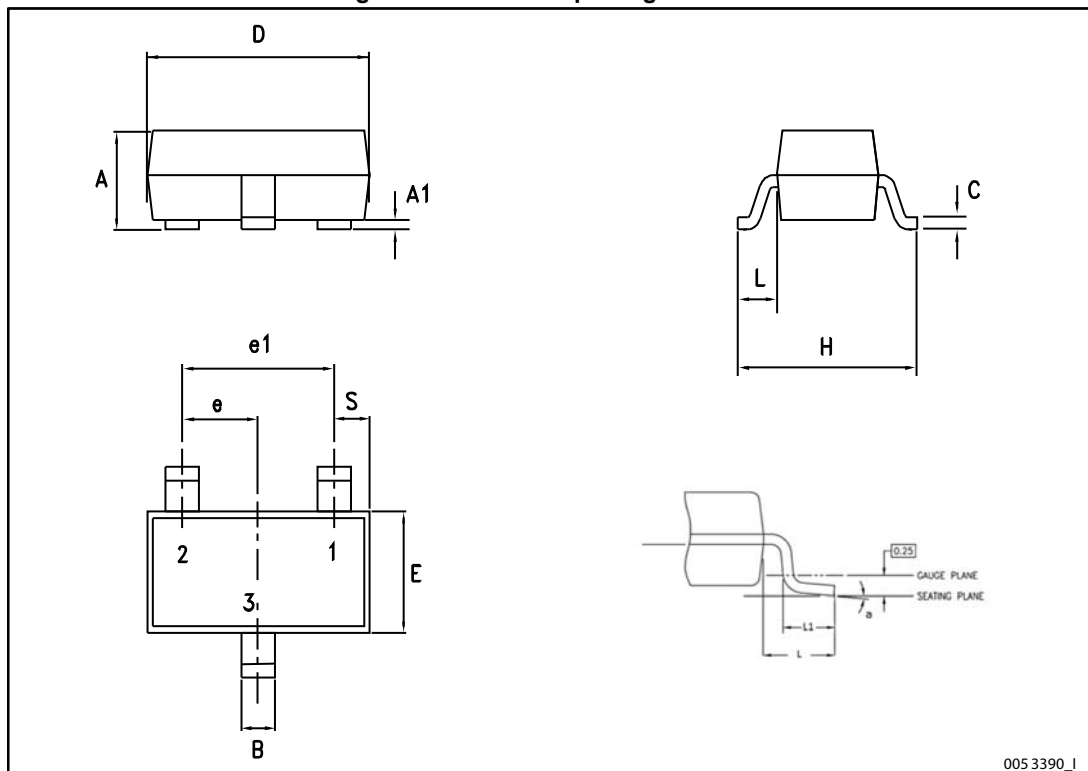
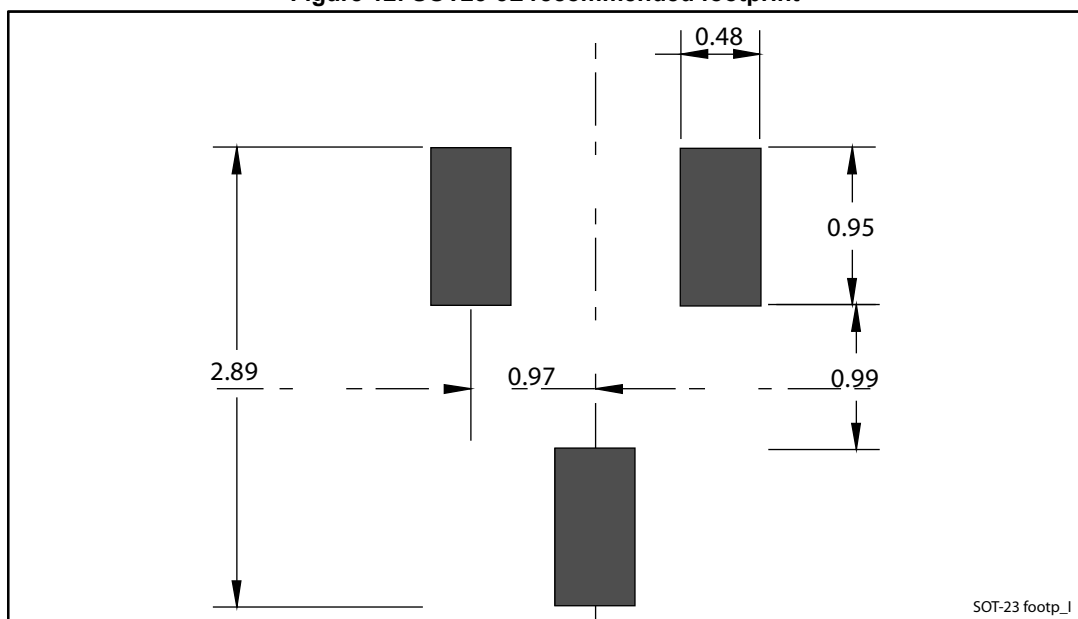

Table 3: SOT23-3L mechanical data

Dim.	mm		
	Min.	Typ.	Max.
A	0.89		1.40
A1	0		0.10
B	0.30		0.51
C	0.085		0.18
D	2.75		3.04
e	0.85		1.05
e1	1.70		2.10
E	1.20		1.75
H	2.10		3.00
L		0.60	
S	0.35		0.65
L1	0.25		0.55
a	0°		8°

Figure 12: SOT23-3L recommended footprint



Dimensions are in mm.

4 Recommendation on PCB assembly

4.1 Solder paste

1. Halide-free flux qualification ROL0 according to ANSI/J-STD-004.
2. "No clean" solder paste is recommended.
3. Offers a high tack force to resist component movement during high speed.
4. Use solder paste with fine particles: powder particle size 20-45 μm .

4.2 Placement

1. Manual positioning is not recommended.
2. It is recommended to use the lead recognition capabilities of the placement system, not the outline centering
3. Standard tolerance of ± 0.05 mm is recommended.
4. 3.5 N placement force is recommended. Too much placement force can lead to squeezed out solder paste and cause solder joints to short. Too low placement force can lead to insufficient contact between package and solder paste that could cause open solder joints or badly centered packages.
5. To improve the package placement accuracy, a bottom side optical control should be performed with a high resolution tool.
6. For assembly, a perfect supporting of the PCB (all the more on flexible PCB) is recommended during solder paste printing, pick and place and reflow soldering by using optimized tools.

4.3 PCB design preference

1. To control the solder paste amount, the closed via is recommended instead of open vias.
2. The position of tracks and open vias in the solder area should be well balanced. A symmetrical layout is recommended, to avoid any tilt phenomena caused by asymmetrical solder paste due to solder flow away.

4.4 Reflow profile

Figure 13: ST ECOPACK® recommended soldering reflow profile for PCB mounting

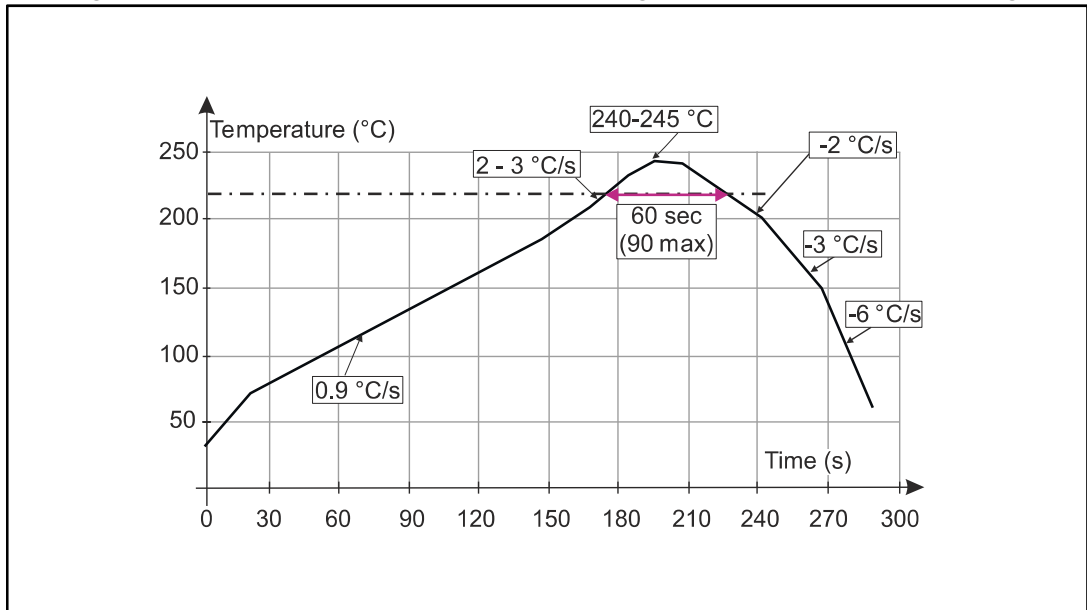

Minimize air convection currents in the reflow oven to avoid component movement.

5 Ordering information

Figure 14: Ordering information scheme

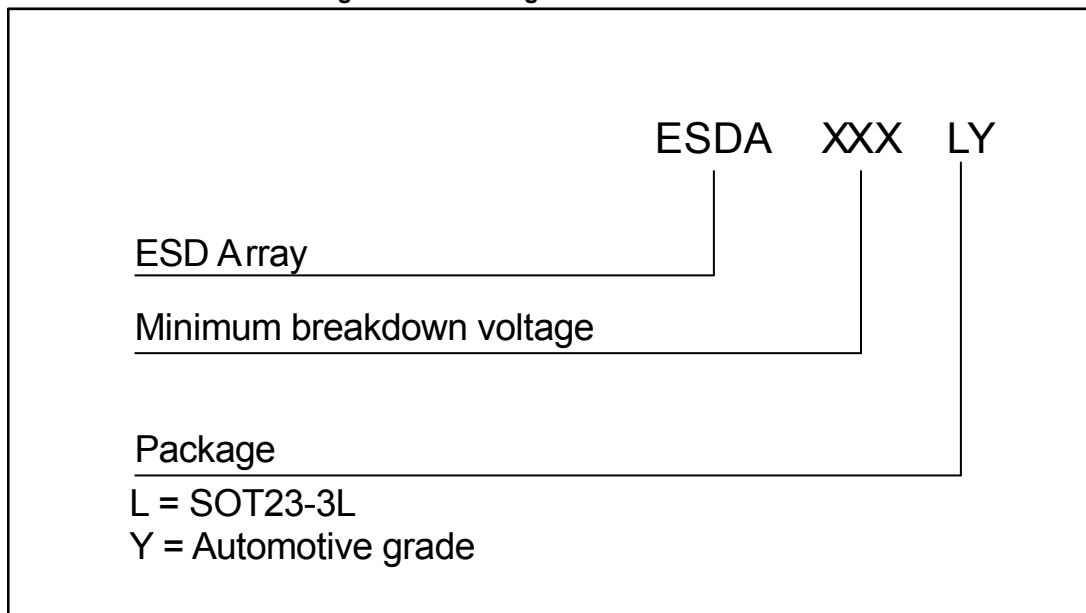

Table 4: Ordering information

Order code	Marking ⁽¹⁾	Package	Weight	Base qty.	Delivery mode
ESDA5V3LY	EL5Y	SOT23-3L	8.7 mg	3000	Tape and reel
ESDA6V1LY	EL6Y				
ESDA14V2LY	EL1Y				
ESDA25LY	EL2Y				
ESDA37LY	EL3Y		9.8 mg		

Notes:

⁽¹⁾The marking can be rotated by multiples of 90° to differentiate assembly location.

6 Revision history

Table 5: Document revision history

Date	Revision	Changes
16-Feb-2012	1	Initial version. This document merges and updates the content of the datasheet ESDA25LY Revision 1, 01-Feb-2010.
20-Jul-2017	2	Added ESDA37LY package information.

IMPORTANT NOTICE – PLEASE READ CAREFULLY

STMicroelectronics NV and its subsidiaries ("ST") reserve the right to make changes, corrections, enhancements, modifications, and improvements to ST products and/or to this document at any time without notice. Purchasers should obtain the latest relevant information on ST products before placing orders. ST products are sold pursuant to ST's terms and conditions of sale in place at the time of order acknowledgement.

Purchasers are solely responsible for the choice, selection, and use of ST products and ST assumes no liability for application assistance or the design of Purchasers' products.

No license, express or implied, to any intellectual property right is granted by ST herein.

Resale of ST products with provisions different from the information set forth herein shall void any warranty granted by ST for such product.

ST and the ST logo are trademarks of ST. All other product or service names are the property of their respective owners.

Information in this document supersedes and replaces information previously supplied in any prior versions of this document.

© 2017 STMicroelectronics – All rights reserved

Mouser Electronics

Authorized Distributor

Click to View Pricing, Inventory, Delivery & Lifecycle Information:

[STMicroelectronics:](#)

[ESDA25LY](#) [ESDA14V2LY](#) [ESDA6V1LY](#) [ESDA5V3LY](#) [ESDA37LY](#)