

# Contents

- 1      Block diagram, test and application circuit ..... 5**
  - 1.1    Block diagram ..... 5
  - 1.2    Test and application circuit ..... 6
  
- 2      Pins description ..... 7**
  
- 3      Electrical specifications ..... 9**
  - 3.1    Absolute maximum ratings ..... 9
  - 3.2    Thermal data ..... 9
  - 3.3    Electrical characteristics ..... 9
  - 3.4    Low voltage operation ('start stop') ..... 11
  - 3.5    Electrical characteristics curves ..... 12
  
- 4      Package information ..... 16**
  - 4.1    Multiwatt 11 (vertical) package mechanical data ..... 16
  - 4.2    PowerSO-20 (slug-down) package mechanical data ..... 18
  - 4.3    PowerSO-20 (slug-up) package mechanical data ..... 20
  
- 5      Revision history ..... 22**

## List of tables

Table 1.	Device summary . . . . .	1
Table 2.	Pins function . . . . .	7
Table 3.	Absolute maximum ratings . . . . .	9
Table 4.	Thermal data . . . . .	9
Table 5.	Electrical characteristics . . . . .	9
Table 6.	Multiwatt 11 (vertical) package mechanical data . . . . .	16
Table 7.	PowerSO-20 (slug-down) package mechanical data . . . . .	18
Table 8.	PowerSO-20 (slug-up) package mechanical data . . . . .	20
Table 9.	Document revision history . . . . .	22

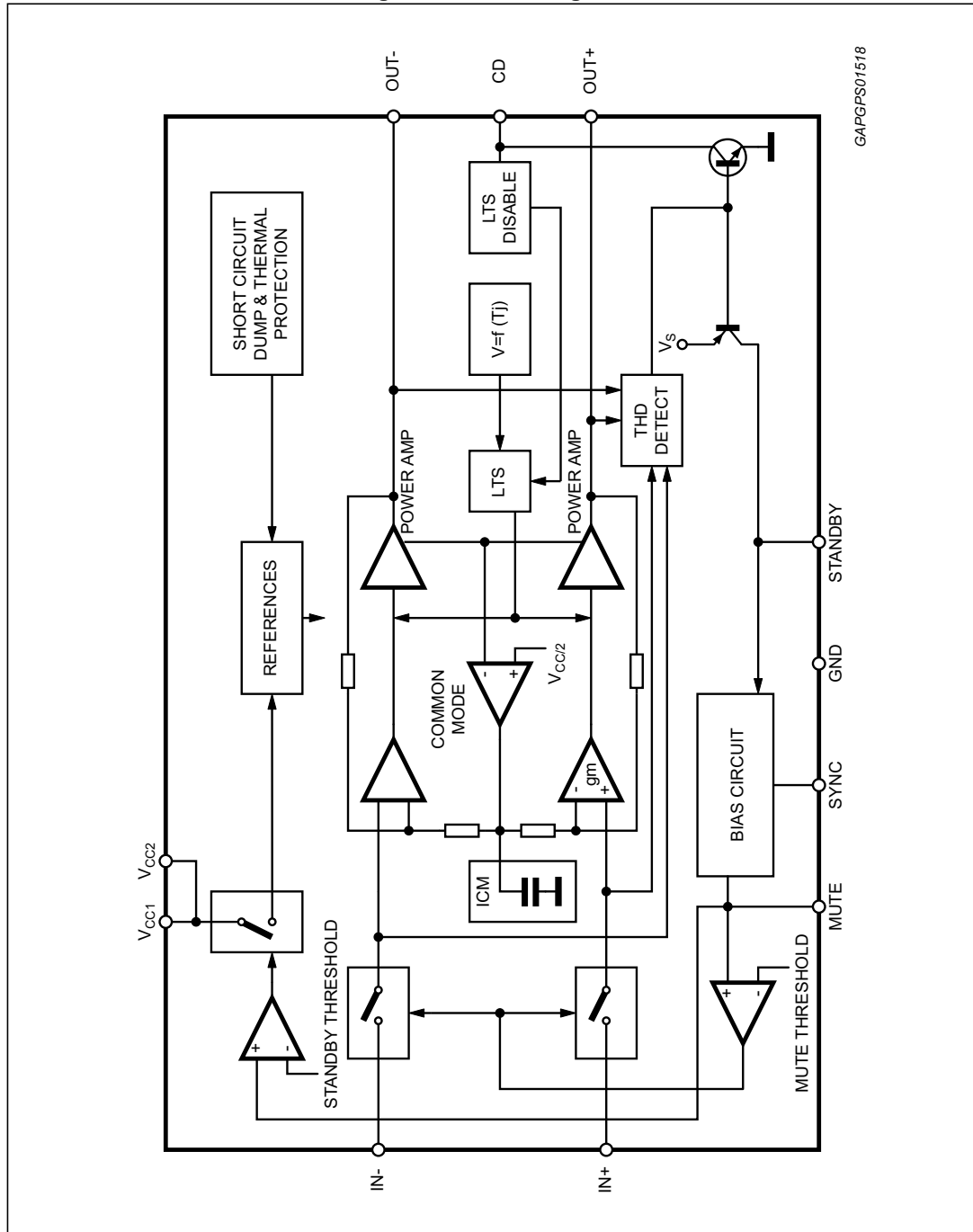
## List of figures

Figure 1.	Block diagram . . . . .	5
Figure 2.	Test and application circuit . . . . .	6
Figure 3.	Multiwatt 11 pins connection (top view) . . . . .	7
Figure 4.	PowerSO-20 pins connection . . . . .	7
Figure 5.	Worst case battery cranking curve sample 1 . . . . .	11
Figure 6.	Worst case battery cranking curve sample 2 . . . . .	11
Figure 7.	Quiescent current vs. supply voltage . . . . .	12
Figure 8.	Output power vs. supply voltage ( $R_L = 3.2 \Omega$ ) . . . . .	12
Figure 9.	Output power vs. supply voltage ( $R_L = 4 \Omega$ ) . . . . .	12
Figure 10.	Output power vs. supply voltage ( $R_L = 8 \Omega$ ) . . . . .	12
Figure 11.	Distortion vs. output power ( $R_L = 3.2 \Omega$ ) . . . . .	12
Figure 12.	Distortion vs. frequency ( $R_L = 3.2 \Omega$ ) . . . . .	12
Figure 13.	Distortion vs. output power ( $R_L = 4 \Omega$ ) . . . . .	13
Figure 14.	Distortion vs. frequency ( $R_L = 4 \Omega$ ) . . . . .	13
Figure 15.	Distortion vs. output power ( $R_L = 8 \Omega$ ) . . . . .	13
Figure 16.	Distortion vs. frequency ( $R_L = 8 \Omega$ ) . . . . .	13
Figure 17.	Distortion vs. output power ( $R_L = 4 \Omega, V_s = 6 V$ ) . . . . .	13
Figure 18.	Distortion vs. frequency ( $R_L = 4 \Omega, V_s = 6 V$ ) . . . . .	13
Figure 19.	Distortion vs. output power ( $R_L = 8 \Omega, V_s = 6 V$ ) . . . . .	14
Figure 20.	Distortion vs. frequency ( $R_L = 8 \Omega, V_s = 6 V$ ) . . . . .	14
Figure 21.	Supply voltage rejection vs. frequency . . . . .	14
Figure 22.	Common mode rejection vs. frequency . . . . .	14
Figure 23.	Total power dissipation and efficiency vs. output power ( $R_L = 4 \Omega$ ) . . . . .	14
Figure 24.	Power dissipation vs. average output power (audio program simulation, $R_L = 4 \Omega$ ) . . . . .	14
Figure 25.	Power dissipation vs. average output power (audio program simulation, $R_L = 4 \Omega$ & $8 \Omega, V_s = 6 V$ ) . . . . .	15
Figure 26.	Power dissipation vs. output power ( $R_L = 4 \Omega$ & $8 \Omega$ , sine, $V_s = 6 V$ ) . . . . .	15
Figure 27.	Multiwatt 11 (vertical) package mechanical drawing . . . . .	16
Figure 28.	PowerSO-20 (slug-down) package mechanical drawing . . . . .	18
Figure 29.	PowerSO-20 (slug-up) package mechanical drawing . . . . .	20

# 1 Block diagram, test and application circuit

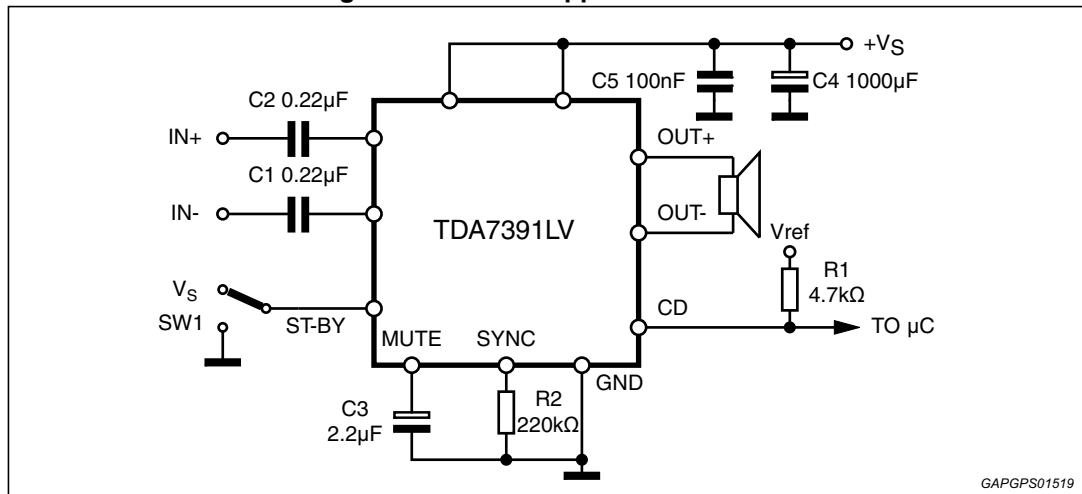
## 1.1 Block diagram

Figure 1. Block diagram



## 1.2 Test and application circuit

Figure 2. Test and application circuit



## 2 Pins description

Figure 3. Multiwatt 11 pins connection (top view)

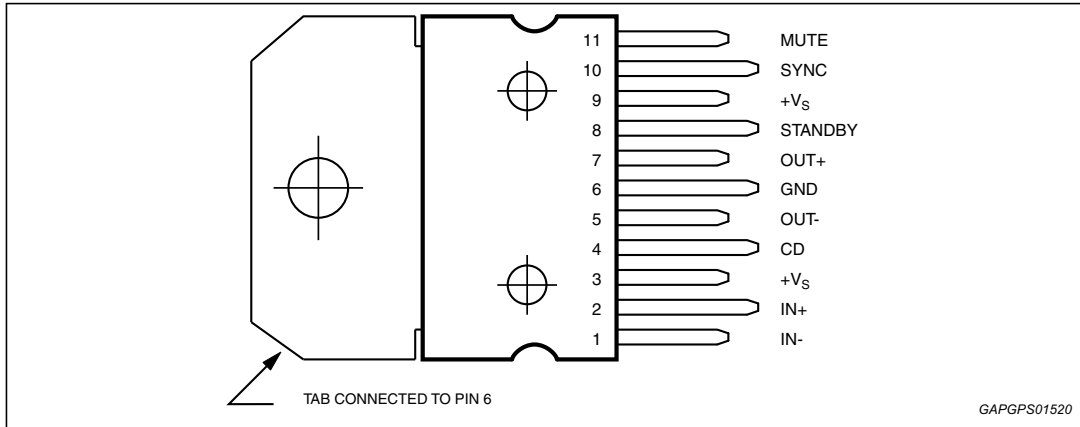


Figure 4. PowerSO-20 pins connection

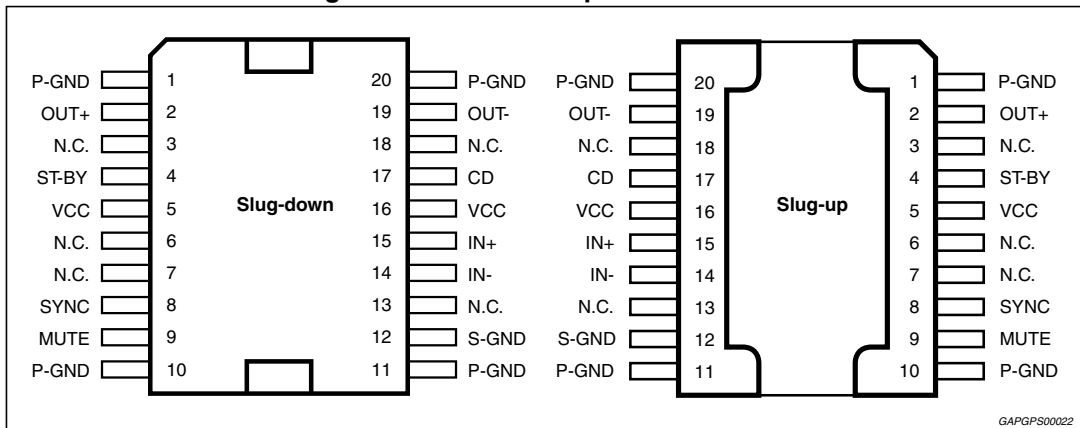


Table 2. Pins function

Multiwatt 11 Pin #	PowerSO-20 Pin #	Name	Description
1, 2	14, 15	INPUTS	The input stage is a high impedance type also capable of operation in single ended mode with one input capacitively coupled to the signal GND. The impedance seen by the inverting and non inverting input pins must be matched.
3, 9	5, 16	+V <sub>S</sub>	Supply voltage.
4	17	CD	The TDA7391LV is equipped with a diagnostic circuitry able to detect the clipping in the Output Signal (distortion = 10%). The CD pin (open collector) gives out low level signal during clipping.

Table 2. Pins function (continued)

Multiwatt 11 Pin #	PowerSO-20 Pin #	Name	Description
5, 7	2, 19	OUTPUTS	The output stage is a bridge type able to drive loads as low as 3.2 $\Omega$ . It consists of two class AB fully complementary PNP/NPN stages fully protected. A rail to rail output voltage swing is achieved without need of bootstrap capacitors. No external compensation is necessary.
6	1, 10, 11, 20	GND	Power ground.
	12	S-GND	Signal ground.
8	4	STANDBY	The device features a standby function which shuts down all the internal bias supplies when the standby pin is low. In standby mode the amplifier sinks a small current (in the range of few $\mu\text{A}$ ). When the standby pin is high the IC becomes fully operational.
10	8	SYNC	A resistor ( $R_2$ ) between pin 8 and GND set the charging current of capacitor $C_3$ (pin 9). The suggested values of $C_3$ and $R_2$ define the correct timing in order to switch on/off the amplifier without any pop noise.
11	9	MUTE	The pin is connected to a capacitor ( $C_3$ ) tied to GND to set the mute/standby time. An automatic mute during turn on/off is provided to prevent noisy transients.

## 3 Electrical specifications

### 3.1 Absolute maximum ratings

Table 3. Absolute maximum ratings

Symbol	Parameter	Value	Unit
$V_S$	DC supply voltage	28	V
$V_{OP}$	Operating supply voltage	18	V
$V_{PEAK}$	Peak supply voltage (t = 50 ms)	50	V
$I_O$	Output peak current repetitive (f > 10 Hz)	4.5	A
	Output peak current non repetitive	6	A
$P_{tot}$	Power dissipation ( $T_{case} = 85\text{ °C}$ )	43	W
$T_{stg}, T_j$	Storage and junction temperature	-40 to 150	°C

### 3.2 Thermal data

Table 4. Thermal data

Symbol	Parameter	Multiwatt	PowerSO	Unit
$R_{th\ j-case}$	Thermal resistance junction-to-case Max.	1.8	2	°C/W

### 3.3 Electrical characteristics

$V_S = 14.4\text{ V}$ ;  $R_L = 4\ \Omega$ ,  $f = 1\text{ kHz}$ ,  $T_{amb} = 25\text{ °C}$ , unless otherwise specified.

Table 5. Electrical characteristics

Symbol	Parameter	Test condition	Min.	Typ.	Max.	Unit
$V_S$	Supply voltage range	-	6	-	18	V
$I_q$	Total quiescent current	-	-	60	150	mA
$V_{OS}$	Output offset voltage	-	-	-	120	mV
$I_{SB}$	Standby current	$V_{ST-BY} = 1.5\text{ V}$	-	-	50	μA
$I_{SBin}$	Standby input bias current	$V_{ST-BY} = 5\text{ V}$	-	-	10	μA
$V_{SBon}$	Standby on threshold voltage	-	-	-	1.5	V
$V_{SBoff}$	Standby off threshold voltage	-	3.5	-	-	V
$ATT_{ST-BY}$	Standby attenuation	-	-	90	-	dB
$I_{M\ in}$	Mute input bias current	( $V_{MUTE} = 5\text{ V}$ )	-	-	10	μA
$A_M$	Mute attenuation	-	-	90	-	dB



Table 5. Electrical characteristics (continued)

Symbol	Parameter	Test condition	Min.	Typ.	Max.	Unit
$P_O$	Output power	THD = 10 %	20	26	-	W
		THD = 1 %	-	21	-	W
		THD = 10 %; $R_L = 3.2 \Omega$	-	32	-	W
		$V_S = 6 \text{ V}$ ; THD = 10 %	-	4.2	-	W
$P_{O \text{ MAX}}$	Max. output power <sup>(1)</sup>	$V_S = 14.4 \text{ V}$ ; $R_L = 3.2 \Omega$	-	45	-	W
		$V_S = 6 \text{ V}$ ; THD = 10 %	-	6	-	W
THD	Total harmonic distortion	-	-	0.06	-	%
		$P_O = 0.1 \text{ to } 15 \text{ W}$	-	0.03	-	%
		$V_S = 6 \text{ V}$ ; $P_O = 1 \text{ W}$		0.05		%
		$V_S = 6 \text{ V}$ ; $P_O = 3.5 \text{ W}$		1.5		%
$G_V$	Voltage gain	-	29.5	30	30.5	dB
$f_H$	High frequency roll-off	$P_O = 1 \text{ W}$ ; -3 dB	75	-	-	kHz
$R_{IN}$	Input Impedance	Differential	36	60	-	k $\Omega$
		Single ended	30	55	-	k $\Omega$
$E_{IN}$	Input noise voltage	$R_g = 0 \Omega$ ; $f = 22 \text{ Hz to } 22 \text{ kHz}$	-	4	-	mV
CMRR	Input common mode rejection	$f = 1 \text{ kHz}$ ; $V_{IN} = 1 \text{ V}_{rms}$	-	65	-	dB
SVR	Supply voltage rejection	$R_g = 0 \Omega$ ; $V_r = 1 \text{ V}_{rms}$	-	60	-	dB
CDL	Clipping detection level	-	5	10	15	%
$T_{sd}$	Absolute thermal shutdown junction temperature	-	-	160	-	$^{\circ}\text{C}$

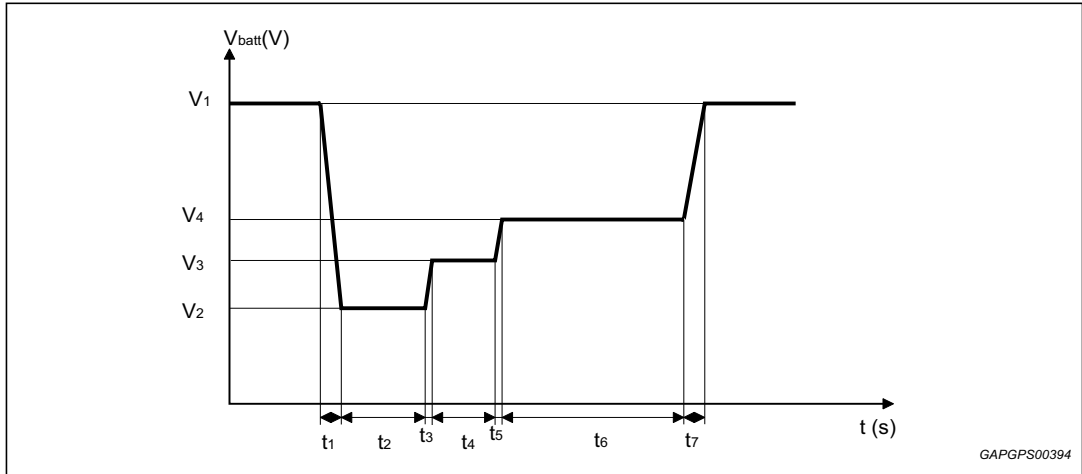
1. Saturated square wave output.

### 3.4 Low voltage operation ('start stop')

The most recent OEM specification are requiring automatic stop of car engine at traffic light, in order to reduce emissions of polluting substances. The TDA7391LV allows a continuous operation when battery falls down to 6/7 V during such conditions. The maximum system power will be reduced accordingly.

Worst case battery cranking curves are shown below, indicating the shape and durations of allowed battery transitions.

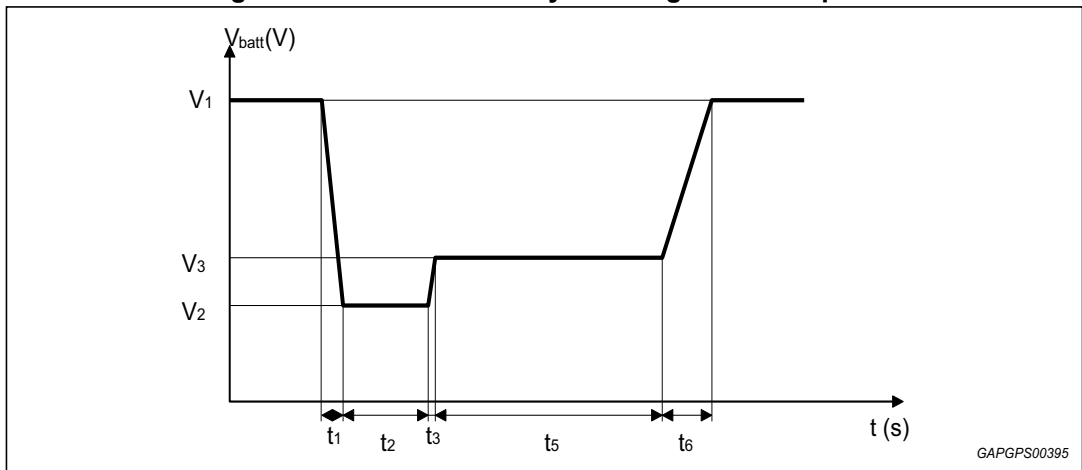
**Figure 5. Worst case battery cranking curve sample 1**



$V_1 = 12\text{ V}$ ;  $V_2 = 6\text{ V}$ ;  $V_3 = 7\text{ V}$ ;  $V_4 = 8\text{ V}$

$t_1 = 2\text{ ms}$ ;  $t_2 = 50\text{ ms}$ ;  $t_3 = 5\text{ ms}$ ;  $t_4 = 300\text{ ms}$ ;  $t_5 = 10\text{ ms}$ ;  $t_6 = 1\text{ s}$ ;  $t_7 = 2\text{ ms}$

**Figure 6. Worst case battery cranking curve sample 2**

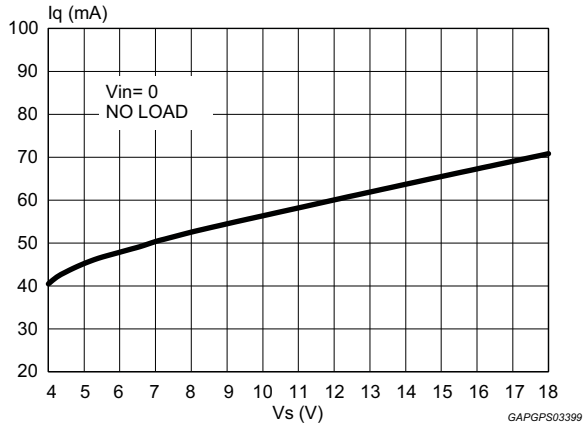


$V_1 = 12\text{ V}$ ;  $V_2 = 6\text{ V}$ ;  $V_3 = 7\text{ V}$

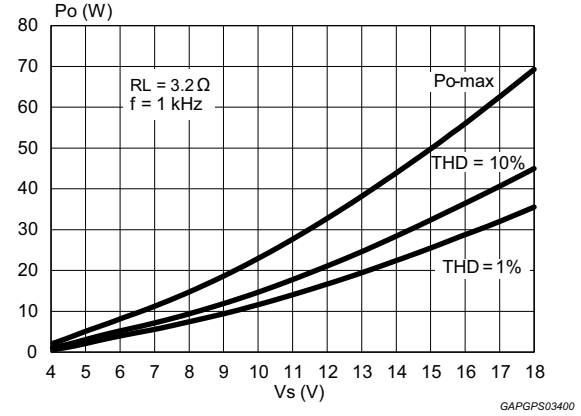
$t_1 = 2\text{ ms}$ ;  $t_2 = 5\text{ ms}$ ;  $t_3 = 15\text{ ms}$ ;  $t_5 = 1\text{ s}$ ;  $t_6 = 50\text{ ms}$

### 3.5 Electrical characteristics curves

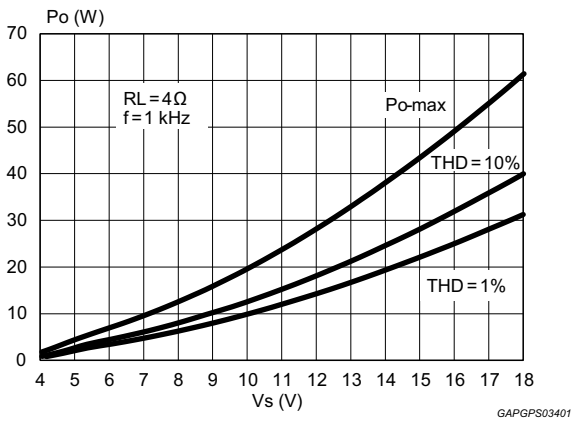
**Figure 7. Quiescent current vs. supply voltage**



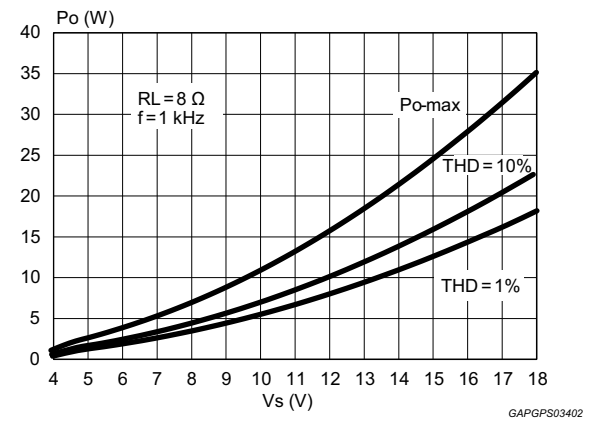
**Figure 8. Output power vs. supply voltage ( $R_L = 3.2 \Omega$ )**



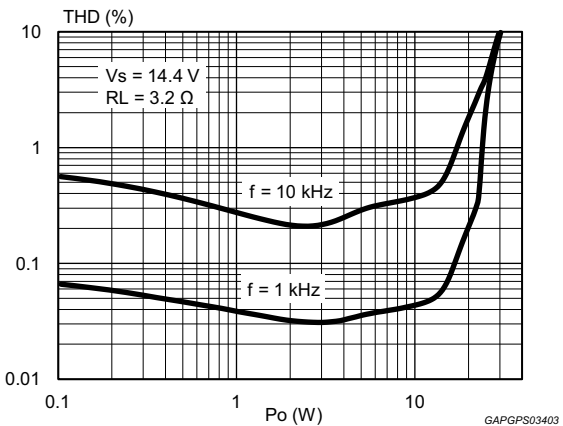
**Figure 9. Output power vs. supply voltage ( $R_L = 4 \Omega$ )**



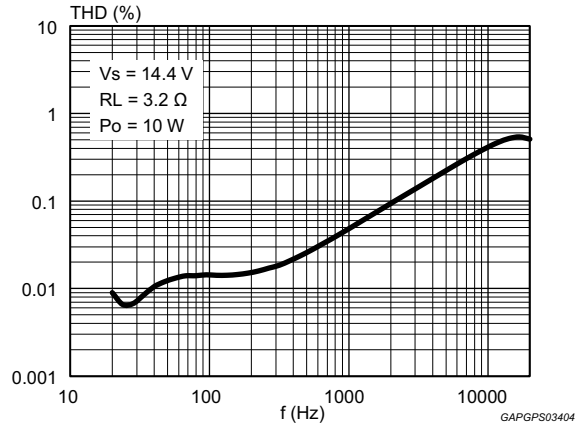
**Figure 10. Output power vs. supply voltage ( $R_L = 8 \Omega$ )**



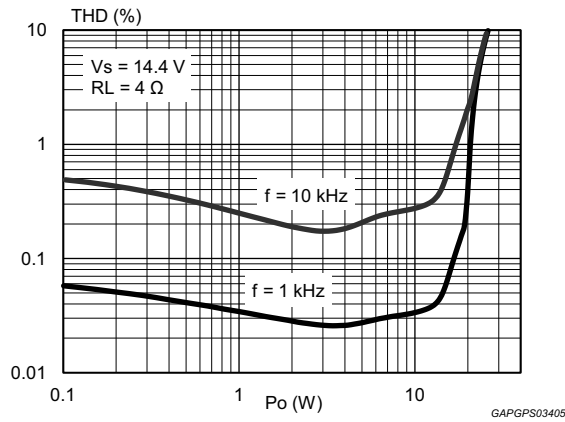
**Figure 11. Distortion vs. output power ( $R_L = 3.2 \Omega$ )**



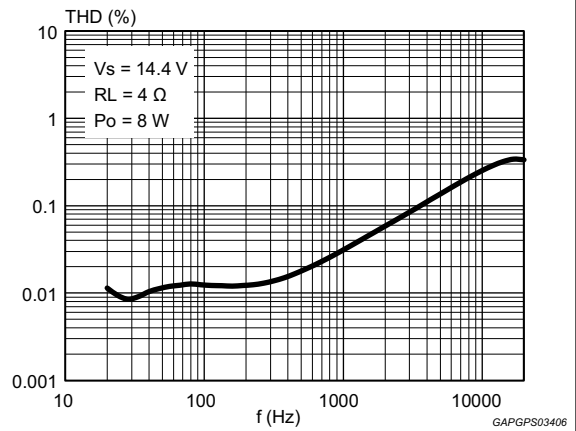
**Figure 12. Distortion vs. frequency ( $R_L = 3.2 \Omega$ )**



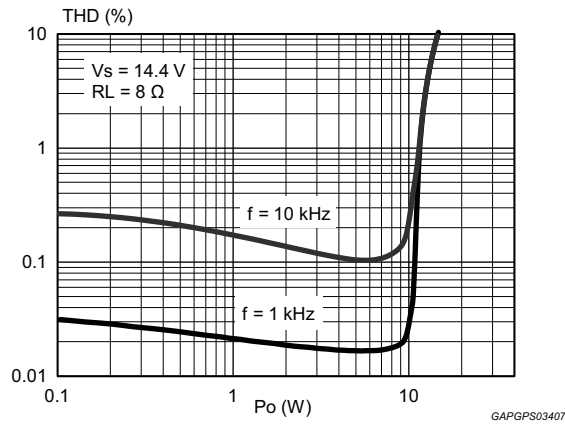
**Figure 13. Distortion vs. output power ( $R_L = 4 \Omega$ )**



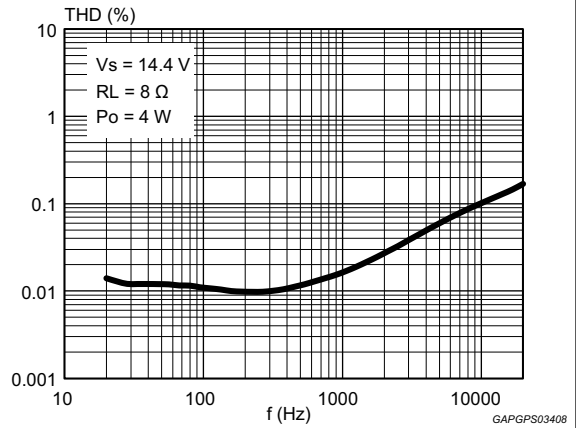
**Figure 14. Distortion vs. frequency ( $R_L = 4 \Omega$ )**



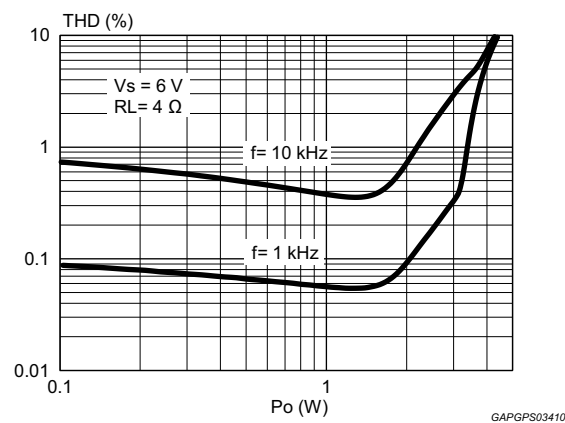
**Figure 15. Distortion vs. output power ( $R_L = 8 \Omega$ )**



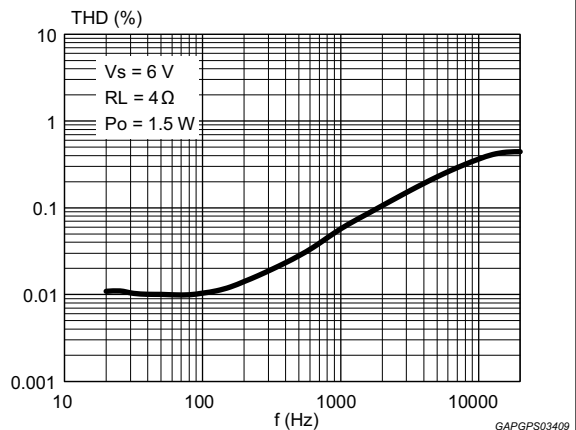
**Figure 16. Distortion vs. frequency ( $R_L = 8 \Omega$ )**

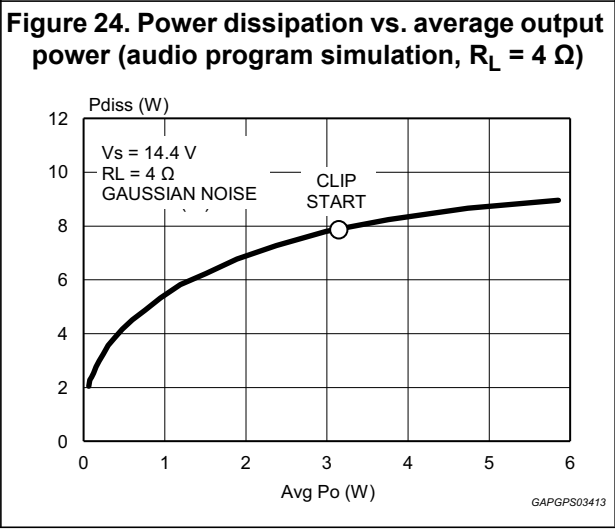
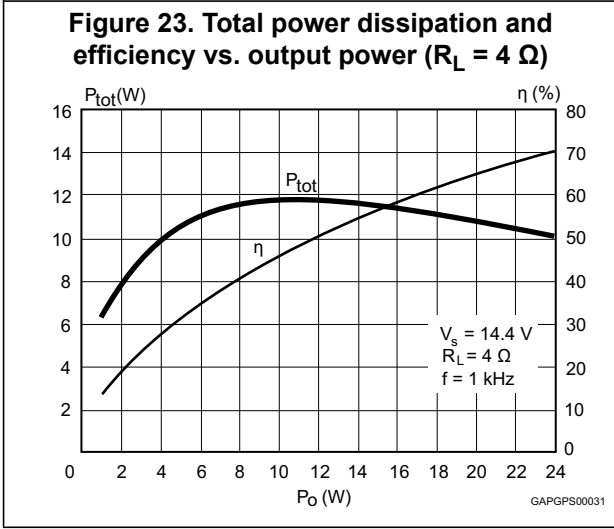
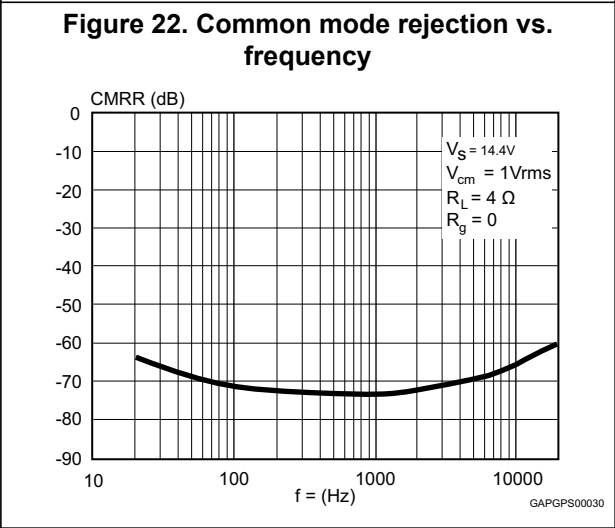
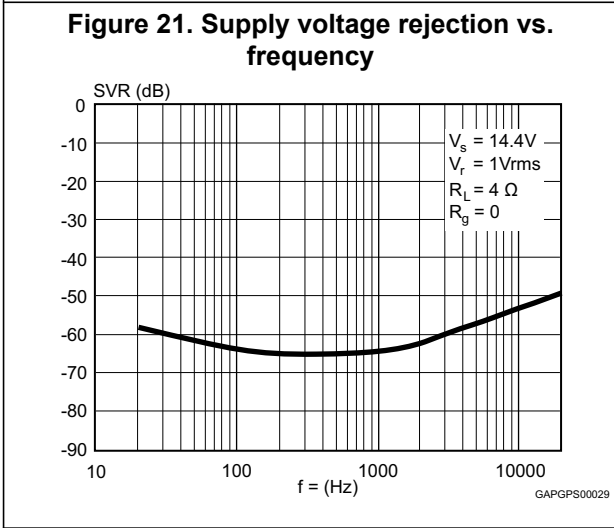
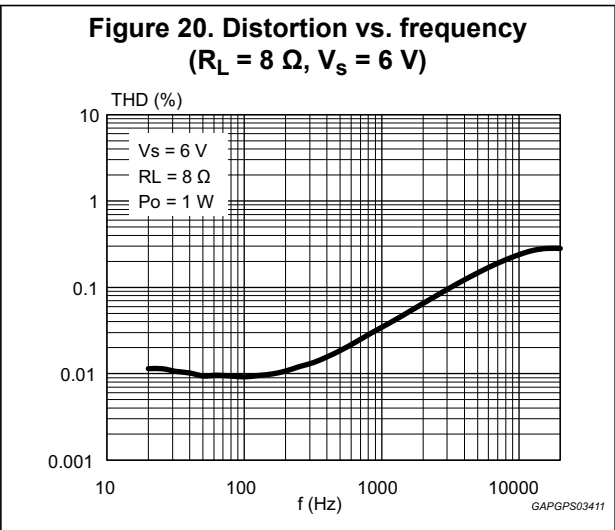
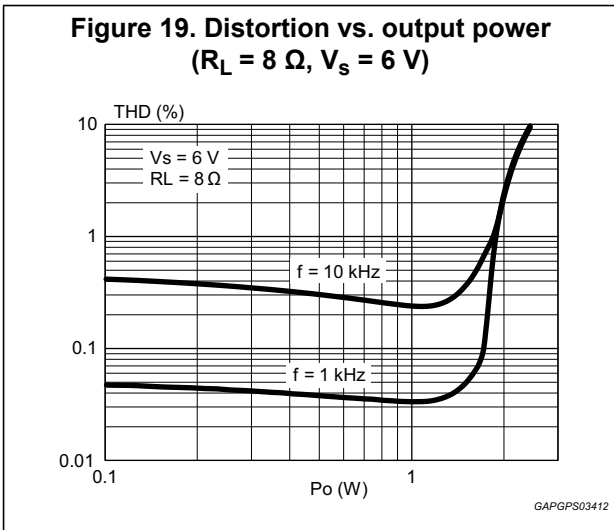


**Figure 17. Distortion vs. output power ( $R_L = 4 \Omega, V_s = 6 \text{ V}$ )**

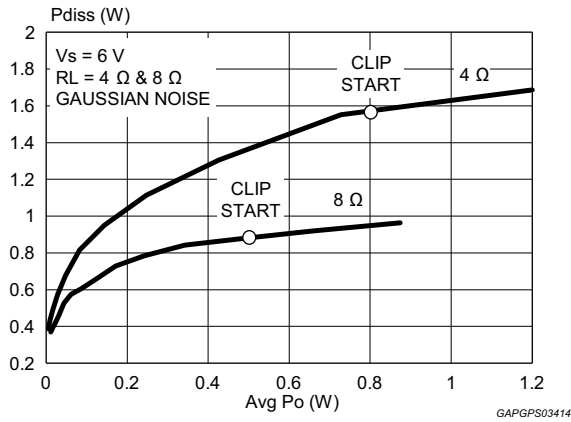


**Figure 18. Distortion vs. frequency ( $R_L = 4 \Omega, V_s = 6 \text{ V}$ )**

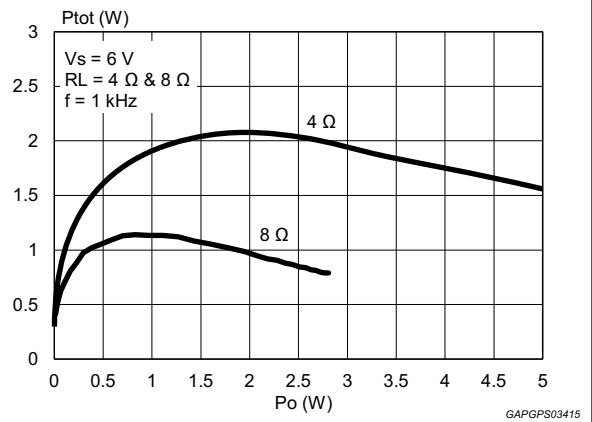




**Figure 25. Power dissipation vs. average output power (audio program simulation,  $R_L = 4 \Omega$  &  $8 \Omega$ ,  $V_s = 6 V$ )**



**Figure 26. Power dissipation vs. output power ( $R_L = 4 \Omega$  &  $8 \Omega$ , sine,  $V_s = 6 V$ )**



## 4 Package information

In order to meet environmental requirements, ST offers these devices in different grades of ECOPACK® packages, depending on their level of environmental compliance. ECOPACK® specifications, grade definitions and product status are available at: [www.st.com](http://www.st.com).

ECOPACK® is an ST trademark.

### 4.1 Multiwatt 11 (vertical) package mechanical data

Figure 27. Multiwatt 11 (vertical) package mechanical drawing

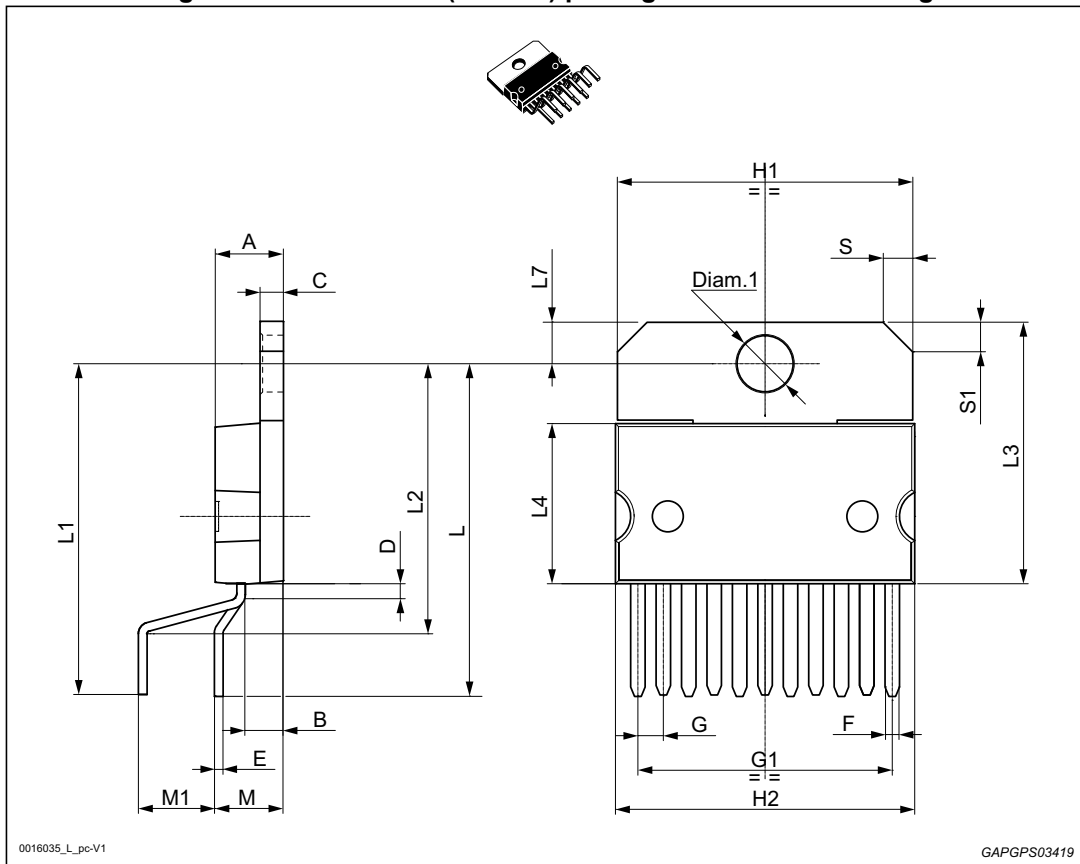


Table 6. Multiwatt 11 (vertical) package mechanical data

Symbol	Millimeters			Inches		
	Min.	Typ.	Max.	Min.	Typ.	Max.
A			5			0.1969
B			2.65			0.1043
C			1.6			0.063
D		1			0.0394	

Table 6. Multiwatt 11 (vertical) package mechanical data (continued)

Symbol	Millimeters			Inches		
	Min.	Typ.	Max.	Min.	Typ.	Max.
E	0.49		0.55	0.0193		0.0217
F	0.88		0.95	0.0346		0.0374
G	1.45	1.7	1.95	0.0571	0.0669	0.0768
G1	16.75	17	17.25	0.6594	0.6693	0.6791
H1	19.6			0.7717		
H2			20.2			0.7953
L	21.9	22.2	22.5	0.8622	0.874	0.8858
L1	21.7	22.1	22.5	0.8543	0.8701	0.8858
L2	17.4		18.1	0.685		0.7126
L3	17.25	17.5	17.75	0.6791	0.689	0.6988
L4	10.3	10.7	10.9	0.4055	0.4213	0.4291
L7	2.65		2.9	0.1043		0.1142
M	4.25	4.55	4.85	0.1673	0.1791	0.1909
M1	4.73	5.08	5.43	0.1862	0.2	0.2138
S	1.9		2.6	0.0748		0.1024
S1	1.9		2.6	0.0748		0.1024
Diam.1	3.65		3.85	0.1437		0.1516



### 4.2 PowerSO-20 (slug-down) package mechanical data

Figure 28. PowerSO-20 (slug-down) package mechanical drawing

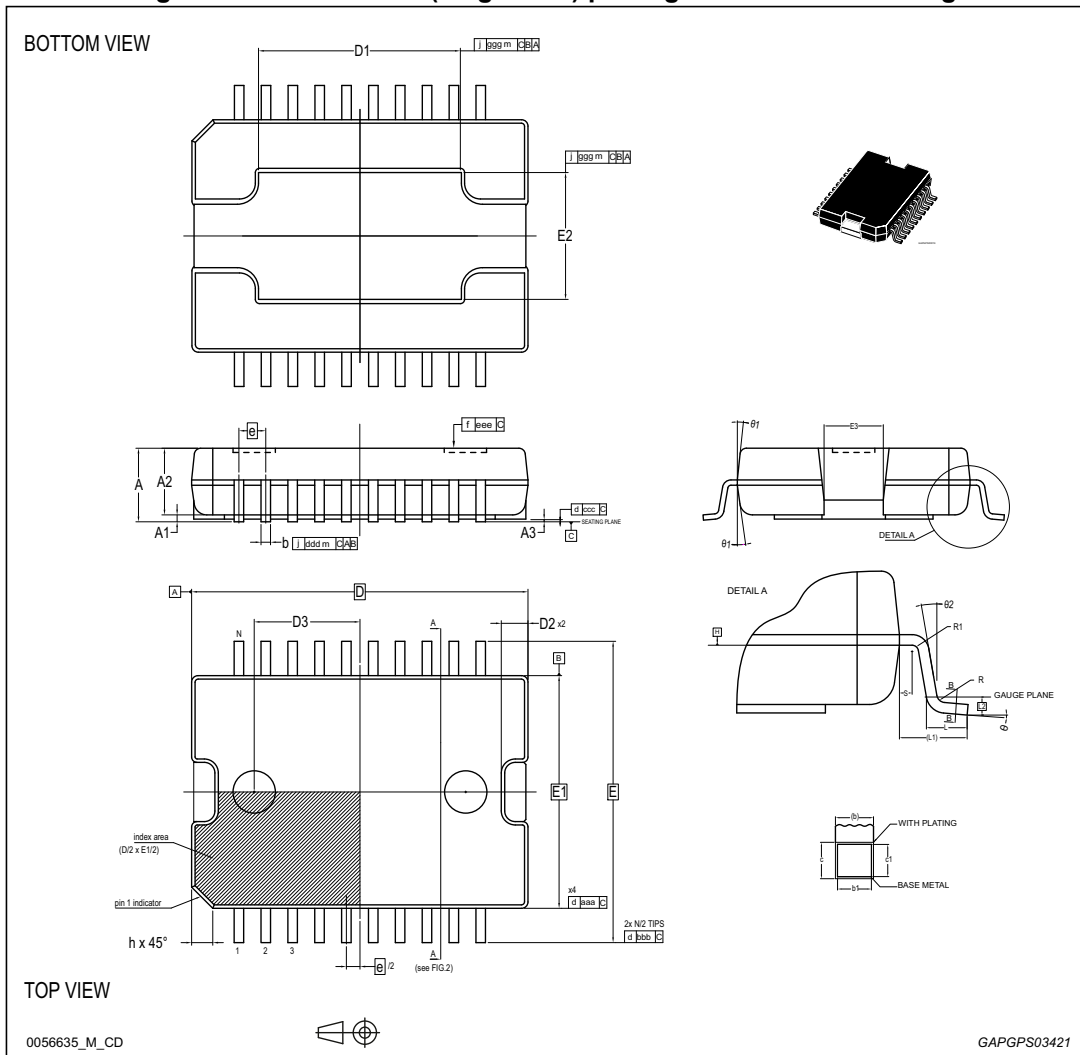


Table 7. PowerSO-20 (slug-down) package mechanical data

Symbol	Millimeters			Inches		
	Min.	Typ.	Max.	Min.	Typ.	Max.
$\theta$	0°		8°	0°		8°
$\theta1$	5°		10°	5°		10°
$\theta2$	0°			0°		
A			3.6			0.1417
A1	0.1			0.0039		
A2	3	3.15	3.3	0.1181	0.124	0.1299
A3			0.1			0.0039

Table 7. PowerSO-20 (slug-down) package mechanical data (continued)

Symbol	Millimeters			Inches		
	Min.	Typ.	Max.	Min.	Typ.	Max.
b	0.4		0.53	0.0157		0.0209
b1	0.4	0.45	0.5	0.0157	0.0177	0.0197
c	0.23		0.32	0.0091		0.0126
c1	0.23	0.25	0.29	0.0091	0.0098	0.0114
D	15.90 BSC			0.626 BSC		
D1 <sup>(1)</sup>	9		13	0.3543		0.5118
D2			1.1			0.0433
D3		5			0.1969	
e	1.27 BSC			0.050 BSC		
E	14.20 BSC			0.5591 BSC		
E1 <sup>(1)</sup>	11.00 BSC			0.4331 BSC		
E2	5.6		6.2	0.2205		0.2441
E3			2.9			0.1142
h			1.1			0.0433
L	0.8		1.1	0.0315		0.0433
L1	1.60 REF			0.063 REF		
L2	0.35 BSC			0.0138 BSC		
N	20			0.7874		
R	0.2			0.0079		
R1	0.2			0.0079		
S	0.25			0.0098		
aaa	0.1			0.0039		
bbb	0.3			0.0118		
ccc	0.1			0.0039		
ddd	0.25			0.0098		
eee	0.1			0.0039		
ggg	0.25			0.0098		

1. Dimensions 'D' and 'E1' do not include mold flash or protrusions. Allowable mold flash or protrusions is "0.25 mm" per side D and "0.15 mm" per side E1. D and E1 are Maximum plastic body size dimensions including mold mismatch.

### 4.3 PowerSO-20 (slug-up) package mechanical data

Figure 29. PowerSO-20 (slug-up) package mechanical drawing

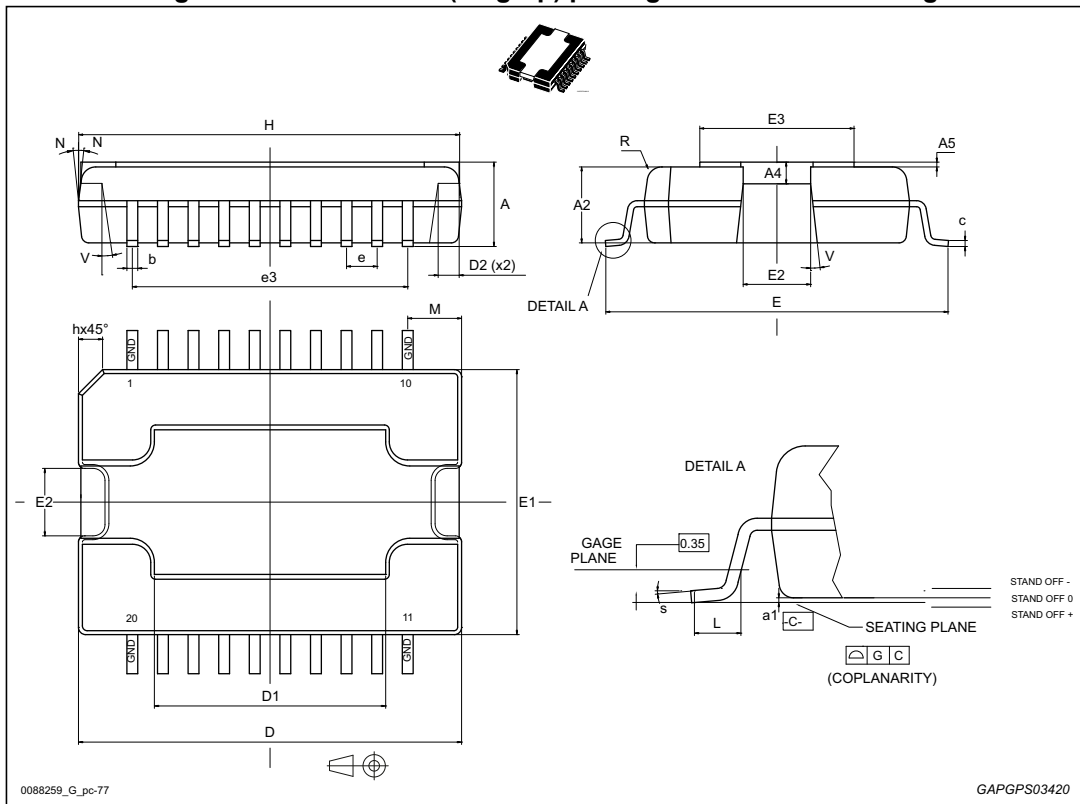


Table 8. PowerSO-20 (slug-up) package mechanical data

Symbol	Millimeters			Inches		
	Min.	Typ.	Max.	Min.	Typ.	Max.
A	3.25		3.5	0.128		0.1378
A2	3	3.15	3.3	0.1181	0.124	0.1299
a1	0.03		-0.04	0.0012		-0.0016
A4	0.8		1	0.0315		0.0394
A5	0.15	0.2	0.25	0.0059	0.0079	0.0098
b	0.4		0.53	0.0157		0.0209
c	0.23		0.32	0.0091		0.0126
D	15.8		16	0.622		0.6299
D1 <sup>(1)</sup>	9.4		9.8	0.3701		0.3858
D2		1			0.0394	
E	13.9		14.5	0.5472		0.5709
e	1.12	1.27	1.42	0.0441	0.05	0.0559
e3		11.43			0.45	

Table 8. PowerSO-20 (slug-up) package mechanical data (continued)

Symbol	Millimeters			Inches		
	Min.	Typ.	Max.	Min.	Typ.	Max.
E1 <sup>(1)</sup>	10.9		11.1	0.4291		0.437
E2			2.9			0.1142
E3	5.8		6.2	0.2283		0.2441
G	0		0.1	0		0.0039
h			1.1			0.0433
H	15.5		15.9	0.6102		0.626
L	0.8		1.1	0.0315		0.0433
N			10d.			10d.
R		0.6			0.0236	
s	0d.		8d.	0d.		8d.
V	5d.		7d.	5d.		7d.

1. 'D' and 'E1' do not include mold flash or protrusions.  
Mold flash or protrusions shall not exceed 0.15 mm (0.006 inches) per side.

## 5 Revision history

**Table 9. Document revision history**

Date	Revision	Changes
29-Mar-2012	1	Initial release.
18-Sep-2013	2	Updated: <i>Features on page 1;</i> <i>Figure 1: Block diagram on page 5;</i> <i>Table 2: Pins function.</i> Updated disclaimer.
01-Dec-2014	3	Updated: <i>Features and Description on page 1;</i> <i>Table 5: Electrical characteristics</i> <i>Section 3.5: Electrical characteristics curves;</i> <i>Section 4: Package information.</i>

**IMPORTANT NOTICE – PLEASE READ CAREFULLY**

STMicroelectronics NV and its subsidiaries (“ST”) reserve the right to make changes, corrections, enhancements, modifications, and improvements to ST products and/or to this document at any time without notice. Purchasers should obtain the latest relevant information on ST products before placing orders. ST products are sold pursuant to ST’s terms and conditions of sale in place at the time of order acknowledgement.

Purchasers are solely responsible for the choice, selection, and use of ST products and ST assumes no liability for application assistance or the design of Purchasers’ products.

No license, express or implied, to any intellectual property right is granted by ST herein.

Resale of ST products with provisions different from the information set forth herein shall void any warranty granted by ST for such product.

ST and the ST logo are trademarks of ST. All other product or service names are the property of their respective owners.

Information in this document supersedes and replaces information previously supplied in any prior versions of this document.

© 2014 STMicroelectronics – All rights reserved

# Mouser Electronics

Authorized Distributor

Click to View Pricing, Inventory, Delivery & Lifecycle Information:

[STMicroelectronics:](#)

[TDA7391LV](#) [TDA7391LVPD](#) [TDA7391LVPDTR](#) [TDA7391LV PDU](#) [TDA7391LVPDUTR](#)