

Electrical Characteristics ($T_J = 25^\circ\text{C}$, unless otherwise specified)

Symbol	Test Conditions		Value	Unit	
I_{GT}	$V_D = 12\text{V}; R_L = 30\ \Omega$	MAX.	40	mA	
		MIN.	5		
V_{GT}	$V_D = 12\text{V}; R_L = 30\ \Omega$	MAX.	1.5	V	
dv/dt	$V_D = V_{DRM}; \text{gate open}; T_J = 100^\circ\text{C}$	MIN.	400V	650	V/ μs
			600V	600	
			800V	500	
	$V_D = V_{DRM}; \text{gate open}; T_J = 125^\circ\text{C}$		400V	250	
			600V	550	
			800V	500	
V_{GD}	$V_D = V_{DRM}; R_L = 3.3\ \text{k}\Omega; T_J = 125^\circ\text{C}$	MIN.	0.2	V	
I_H	$I_T = 400\text{mA}$ (initial)	MAX.	60	mA	
t_q	(1)	MAX.	35	μs	
t_{gt}	$I_G = 2 \times I_{GT}; \text{PW} = 15\ \mu\text{s}; I_T = 110\text{A}$	TYP.	2.5	μs	

Note :

(1) $I_T = 2\text{A}; t_p = 50\ \mu\text{s}; dv/dt = 5\text{V}/\mu\text{s}; di/dt = 30\text{A}/\mu\text{s}$

Static Characteristics

Symbol	Test Conditions		Value	Unit		
V_{TM}	$I_T = 110\text{A}; t_p = 380\ \mu\text{s}$	MAX.	1.8	V		
I_{DRM} / I_{RRM}	V_{DRM} / V_{RRM}	$T_J = 25^\circ\text{C}$	400 – 600V	MAX.	10	μA
			800V		20	
			1000V		30	
		$T_J = 100^\circ\text{C}$	400 – 600V		1000	
			800V		1500	
			1000V		5000	
		$T_J = 125^\circ\text{C}$	400 – 600V		2000	
			800V		3000	

Thermal Resistances

Symbol	Parameter	Value	Unit
$R_{\theta(J-C)}$	Junction to case (AC)	Sxx55R Sxx55N	0.5
		Sxx55W Sxx55M	0.53
$R_{\theta(J-A)}$	Junction to ambient	Sxx55R	40

Note: xx = voltage

Figure 1: Normalized DC Gate Trigger Current vs. Junction Temperature

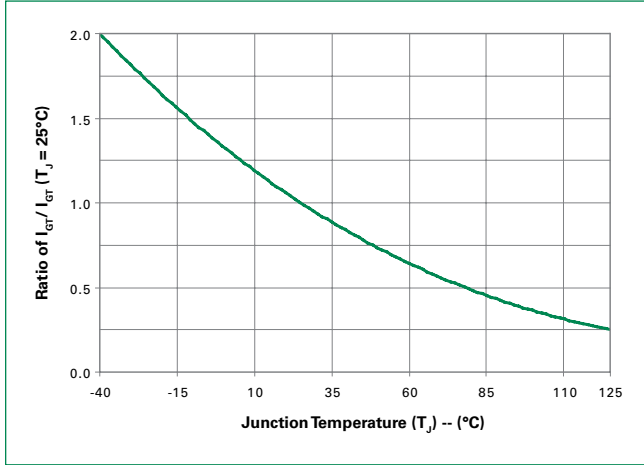

Figure 2: Normalized DC Gate Trigger Voltage vs. Junction Temperature

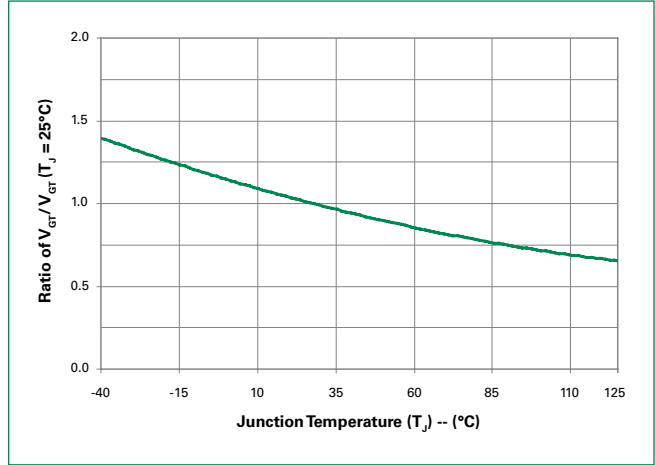

Figure 3: Normalized DC Holding Current vs. Junction Temperature

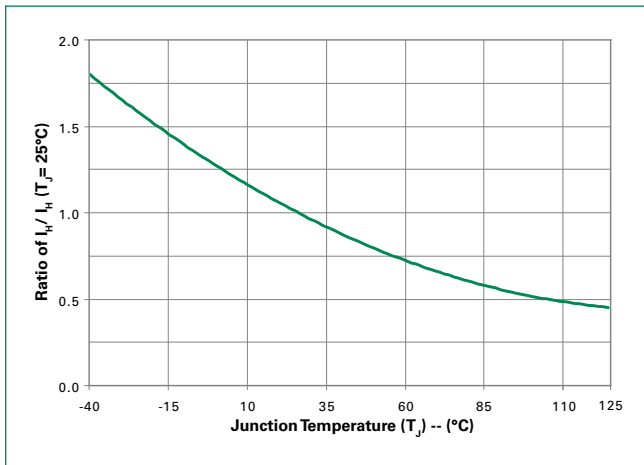

Figure 4: On-State Current vs. On-State Voltage (Typical)

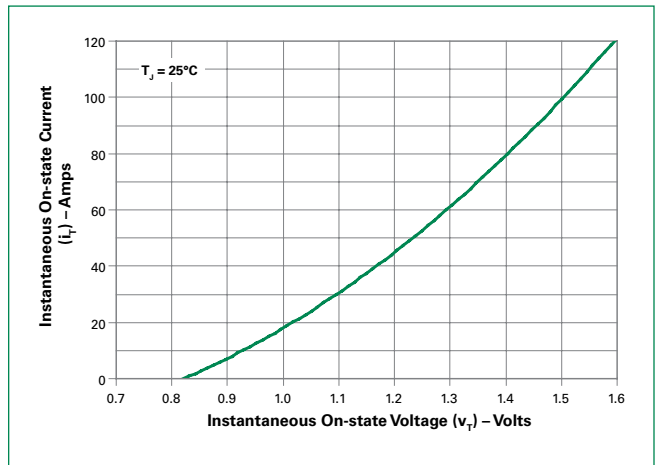

Figure 5: Power Dissipation (Typical) vs. RMS On-State Current

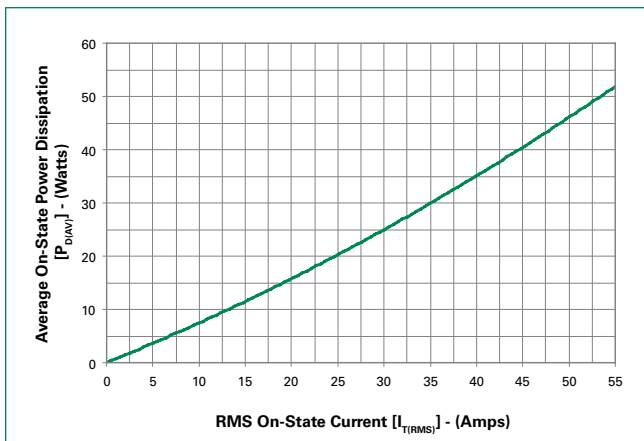
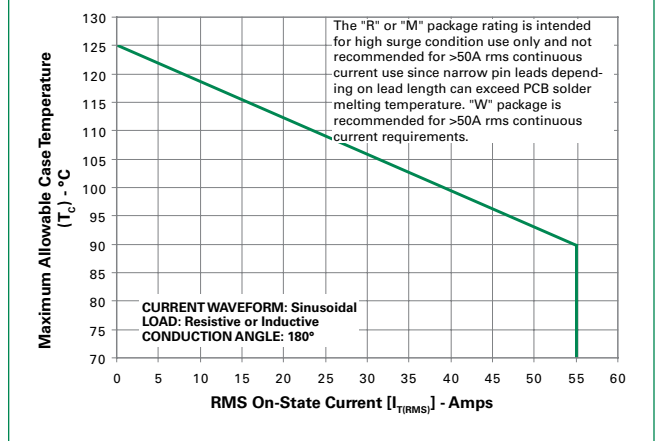

Figure 6: Maximum Allowable Case Temperature vs. RMS On-State Current



Note: xx = voltage

Figure 7: Maximum Allowable Case Temperature vs. Average On-State Current

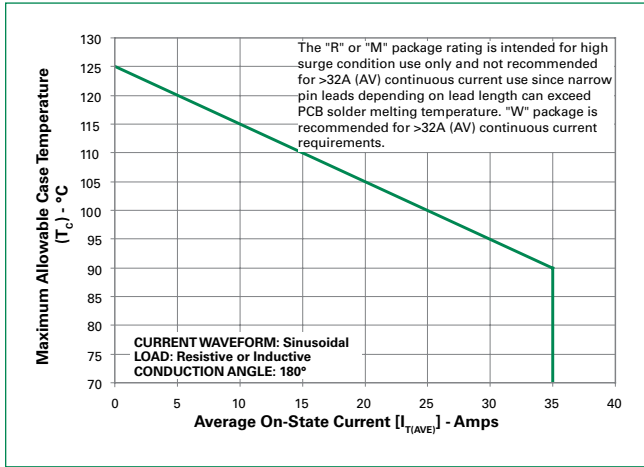

Figure 8: Maximum Allowable Ambient Temperature vs. RMS On-State Current

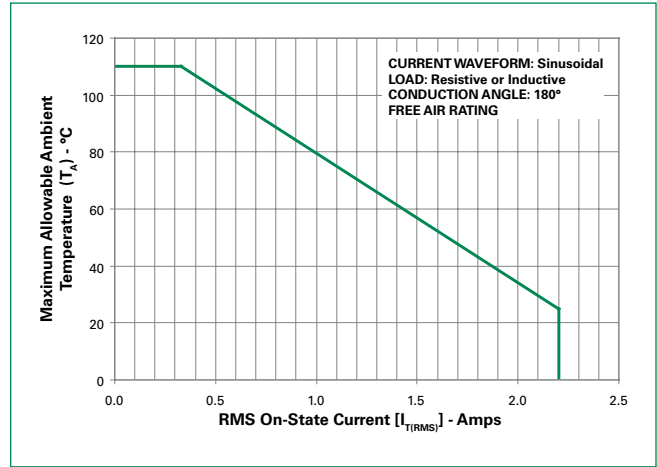

Figure 9: Maximum Allowable Ambient Temperature vs. Average On-State Current

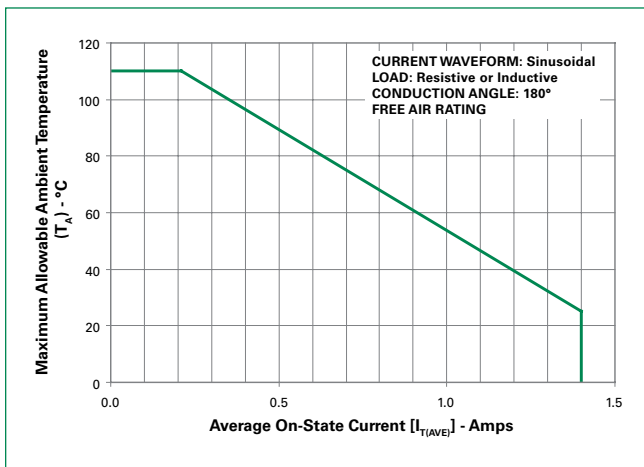

Figure 10: Peak Capacitor Discharge Current

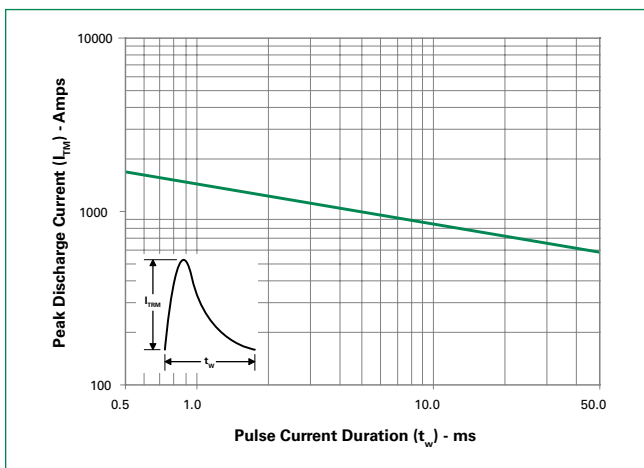
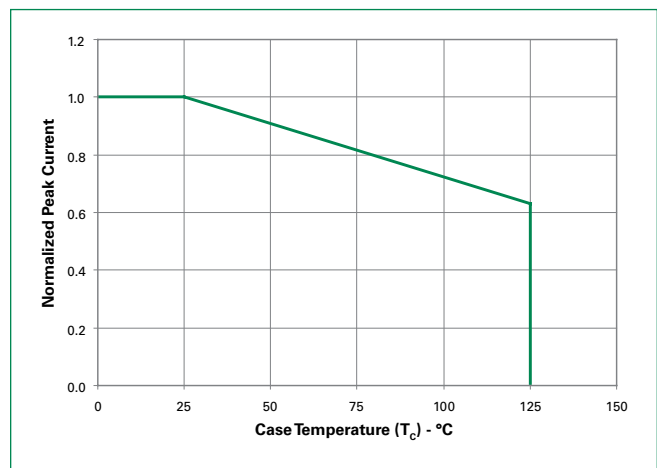
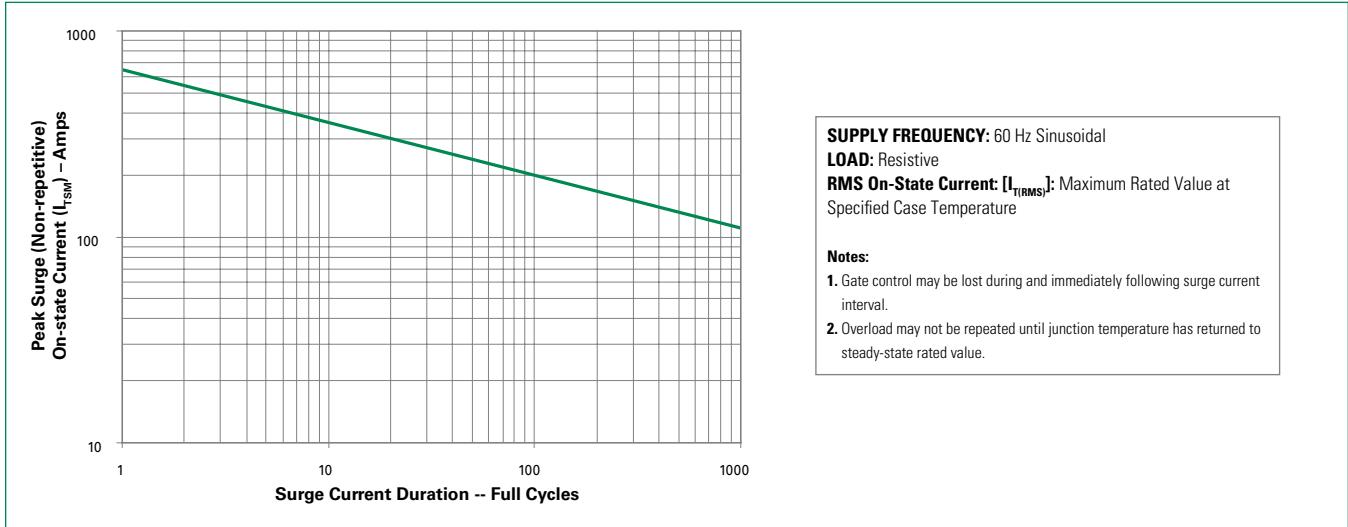

Figure 11: Peak Capacitor Discharge Current Derating



Note: xx = voltage

Figure 12: Surge Peak On-State Current vs. Number of Cycles



Soldering Parameters

Reflow Condition		Pb – Free assembly
Pre Heat	- Temperature Min ($T_{s(min)}$)	150°C
	- Temperature Max ($T_{s(max)}$)	200°C
	- Time (min to max) (t_s)	60 – 180 secs
Average ramp up rate (Liquidus Temp) (T_L) to peak		5°C/second max
$T_{S(max)}$ to T_L - Ramp-up Rate		5°C/second max
Reflow	- Temperature (T_L) (Liquidus)	217°C
	- Temperature (t_L)	60 – 150 seconds
Peak Temperature (T_p)		260 ^{+0/-5} °C
Time within 5°C of actual peak Temperature (t_p)		20 – 40 seconds
Ramp-down Rate		5°C/second max
Time 25°C to peak Temperature (T_p)		8 minutes Max.
Do not exceed		280°C

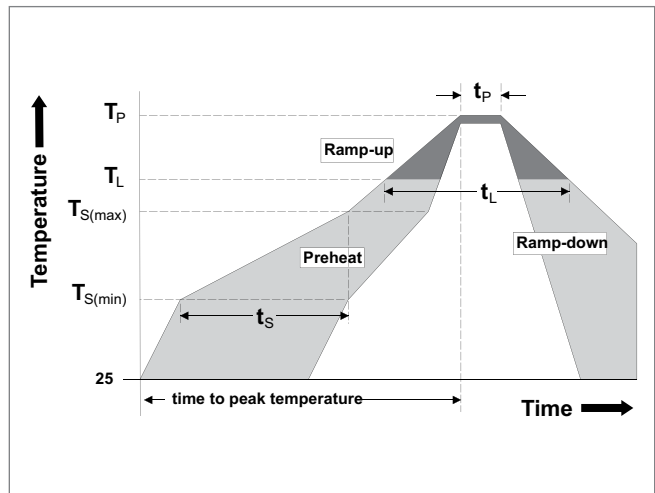

Physical Specifications

Terminal Finish	100% Matte Tin-plated
Body Material	UL recognized epoxy meeting flammability classification 94V-0
Lead Material	Copper Alloy

Design Considerations

Careful selection of the correct device for the application's operating parameters and environment will go a long way toward extending the operating life of the Thyristor. Good design practice should limit the maximum continuous current through the main terminals to 75% of the device rating. Other ways to ensure long life for a power discrete semiconductor are proper heat sinking and selection of voltage ratings for worst case conditions. Overheating, overvoltage (including dv/dt), and surge currents are the main killers of semiconductors. Correct mounting, soldering, and forming of the leads also help protect against component damage.

Environmental Specifications

Test	Specifications and Conditions
AC Blocking	MIL-STD-750, M-1040, Cond A Applied Peak AC voltage @ 125°C for 1008 hours
Temperature Cycling	MIL-STD-750, M-1051, 100 cycles; -40°C to +150°C; 15-min dwell-time
Temperature/Humidity	EIA / JEDEC, JESD22-A101 1008 hours; 320V - DC: 85°C; 85% rel humidity
High Temp Storage	MIL-STD-750, M-1031, 1008 hours; 150°C
Low-Temp Storage	1008 hours; -40°C
Resistance to Solder Heat	MIL-STD-750 Method 2031
Solderability	ANSI/J-STD-002, category 3, Test A
Lead Bend	MIL-STD-750, M-2036 Cond E

Dimensions – TO-220AB (R-Package) – Non-Isolated Mounting Tab Common with Center Lead

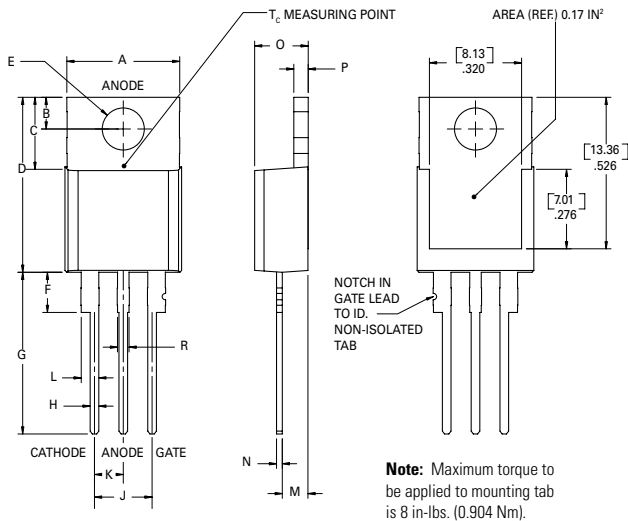

Dimension	Inches		Millimeters	
	Min	Max	Min	Max
A	0.380	0.420	9.65	10.67
B	0.105	0.115	2.67	2.92
C	0.230	0.250	5.84	6.35
D	0.590	0.620	14.99	15.75
E	0.142	0.147	3.61	3.73
F	0.110	0.130	2.79	3.30
G	0.540	0.575	13.72	14.61
H	0.025	0.035	0.64	0.89
J	0.195	0.205	4.95	5.21
K	0.095	0.105	2.41	2.67
L	0.060	0.075	1.52	1.91
M	0.085	0.095	2.16	2.41
N	0.018	0.024	0.46	0.61
O	0.178	0.188	4.52	4.78
P	0.045	0.060	1.14	1.52
R	0.038	0.048	0.97	1.22

Dimensions – TO-263AB (N-package) – D²-Pak Surface Mount

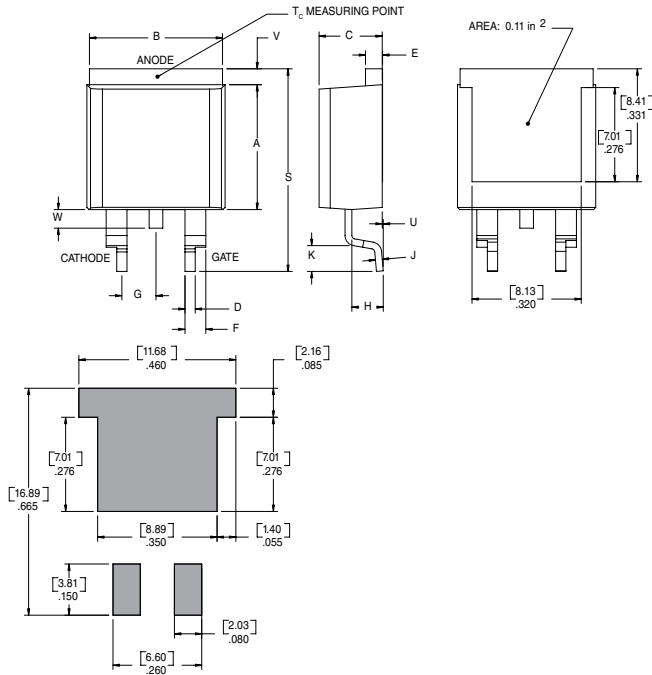

Dimension	Inches		Millimeters	
	Min	Max	Min	Max
A	0.360	0.370	9.14	9.40
B	0.380	0.420	9.65	10.67
C	0.178	0.188	4.52	4.78
D	0.025	0.035	0.63	0.89
E	0.048	0.055	1.22	1.40
F	0.060	0.075	1.52	1.91
G	0.095	0.105	2.41	2.67
H	0.083	0.093	2.11	2.36
J	0.018	0.024	0.46	0.61
K	0.090	0.110	2.29	2.79
S	0.590	0.625	14.99	15.87
V	0.035	0.045	0.89	1.14
U	0.002	0.010	0.05	0.25
W	0.040	0.070	1.02	1.78

Dimensions – TO-218X (W Package) – Non-Isolated Mounting Tab Common with Center Lead

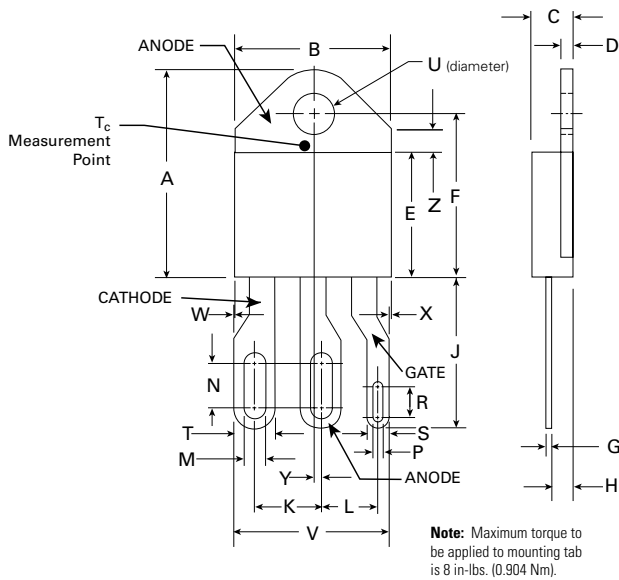

Dimension	Inches		Millimeters	
	Min	Max	Min	Max
A	0.810	0.835	20.57	21.21
B	0.610	0.630	15.49	16.00
C	0.178	0.188	4.52	4.78
D	0.055	0.070	1.40	1.78
E	0.487	0.497	12.37	12.62
F	0.635	0.655	16.13	16.64
G	0.022	0.029	0.56	0.74
H	0.075	0.095	1.91	2.41
J	0.575	0.625	14.61	15.88
K	0.256	0.264	6.50	6.71
L	0.220	0.228	5.58	5.79
M	0.080	0.088	2.03	2.24
N	0.169	0.177	4.29	4.49
P	0.034	0.042	0.86	1.07
R	0.113	0.121	2.87	3.07
S	0.086	0.096	2.18	2.44
T	0.156	0.166	3.96	4.22
U	0.164	0.165	4.10	4.20
V	0.603	0.618	15.31	15.70
W	0.000	0.005	0.00	0.13
X	0.003	0.012	0.07	0.30
Y	0.028	0.032	0.71	0.81
Z	0.085	0.095	2.17	2.42

Dimensions – TO-218AC (M Package) – Non-isolated Mounting Tab Common with Center Lead

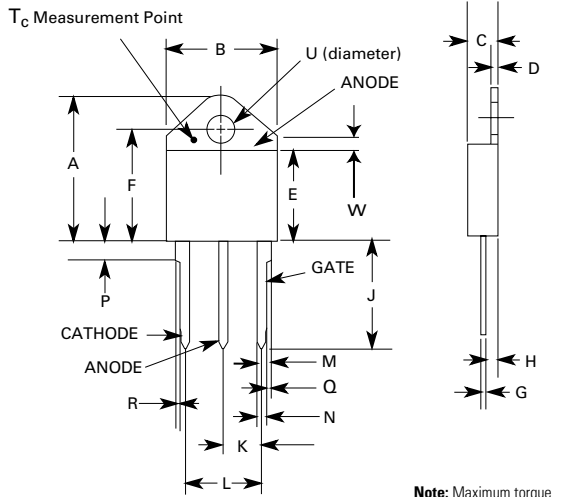

Note: Maximum torque to be applied to mounting tab is 8 in-lbs. (0.904 Nm).

Dimension	Inches		Millimeters	
	Min	Max	Min	Max
A	0.810	0.835	20.57	21.21
B	0.610	0.630	15.49	16.00
C	0.178	0.188	4.52	4.78
D	0.055	0.070	1.40	1.78
E	0.487	0.497	12.37	12.62
F	0.635	0.655	16.13	16.64
G	0.022	0.029	0.56	0.74
H	0.075	0.095	1.91	2.41
J	0.575	0.625	14.61	15.88
K	0.211	0.219	5.36	5.56
L	0.422	0.437	10.72	11.10
M	0.058	0.068	1.47	1.73
N	0.045	0.055	1.14	1.40
P	0.095	0.115	2.41	2.92
Q	0.008	0.016	0.20	0.41
R	0.008	0.016	0.20	0.41
U	0.164	0.165	4.10	4.20
W	0.085	0.095	2.17	2.42

Product Selector

Part Number	Voltage				Gate Sensitivity	Type	Package
	400V	600V	800V	1000V			
Sxx55R	X	X	X	X	40mA	Standard SCR	TO-220R
Sxx55N	X	X	X	X	40mA	Standard SCR	TO-263
Sxx55W	X	X	X		40mA	Standard SCR	TO-218X
Sxx55M	X	X	X	X	40mA	Standard SCR	TO-218AC

Note: xx = Voltage

Packing Options

Part Number	Marking	Weight	Packing Mode	Base Quantity
Sxx55RTP	Sxx55R	2.2g	Tube	1000 (50 per tube)
Sxx55NTP	Sxx55N	1.6g	Tube	1000 (50 per tube)
Sxx55NRP	Sxx55N	1.6g	Embossed Carrier	500
Sxx55WTP	Sxx55W	5.23g	Tube	250 (25 per tube)
Sxx55MTP	Sxx55M	4.40g	Tube	250 (25 per tube)

Note: xx = Voltage

TO-263 Embossed Carrier Reel Pack (RP) Specification

Meets all EIA-481-2 Standards

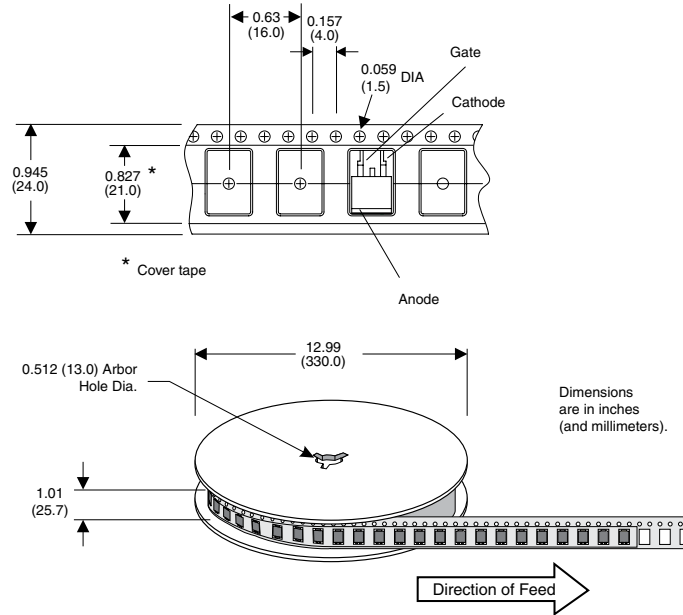

Part Numbering System

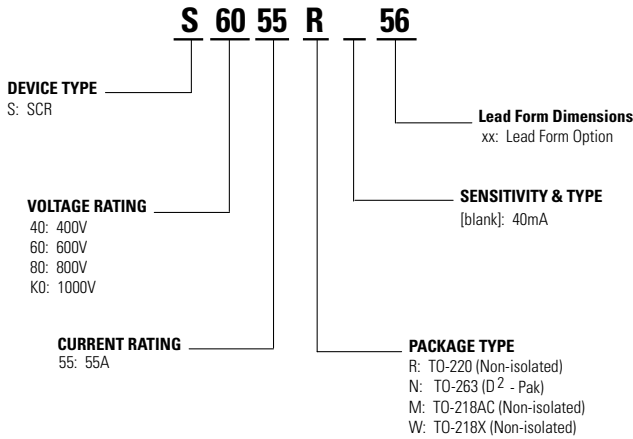

Part Marking System

TO-218AC - (M Package)
TO-218X - (W Package)

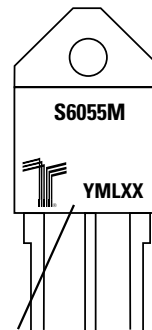

Date Code Marking
Y: Year Code
M: Month Code
L: Location Code
XX: Lot Serial Code

TO-220 AB - (R Package)
TO-263 AB - (N Package)

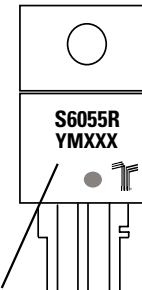

Date Code Marking
Y: Year Code
M: Month Code
XXX: Lot Trace Code

Mouser Electronics

Authorized Distributor

Click to View Pricing, Inventory, Delivery & Lifecycle Information:

Littelfuse:

[S2055W_](#) [S4055NTP](#) [SK055NRP](#) [S2055NRP](#) [S2055NTP](#) [SK055NTP](#) [S8055NRP](#) [S2055W82](#) [S2055RTP](#)
[S8055R67RP](#) [S2055R](#) [S6055M](#) [S6055W](#) [S8055RTP](#) [S8055W](#) [S2055W](#) [S2055W81](#) [S8055M](#) [S6055NRP](#) [S6055R](#)
[S8055R67](#) [S6055W_](#) [S8055R](#) [S4055M](#) [S8055NTP](#) [SK055R](#) [S4055R](#) [SK055M](#) [S4055NRP](#) [S6055NTP](#) [S2055M](#)
[S4055W](#) [S2055MTP](#) [S2055WTP](#) [SK055MTP](#) [S4055MTP](#) [S6055WTP](#) [S6055MTP](#) [S4055WTP](#) [S8055MTP](#)
[S8055WTP](#) [S6055RTP](#) [S4055RTP](#) [SK055RTP](#)